

ESIEE Paris  
and  
UNIVERSITY OF WEST BOHEMIA

Faculty of Electrical Engineering  
Department of Applied Electronics and Telecommunications

# DIPLOMA THESIS

Control unit for electric kiln

Author of thesis: Bc. Stepan Blaha  
Supervisor of thesis: Ing. Kamil Kosturik (UWB)  
AP Yasmina Abdeddaim (ESIEE)

Pilsen 2014

ZÁPADOČESKÁ UNIVERZITA V PLZNI

Fakulta elektrotechnická

Akademický rok: 2013/2014

## ZADÁNÍ DIPLOMOVÉ PRÁCE

(PROJEKTU, UMĚLECKÉHO DÍLA, UMĚLECKÉHO VÝKONU)

Jméno a příjmení: **Bc. Štěpán BLÁHA**  
Osobní číslo: **E11N0157P**  
Studijní program: **N2612 Elektrotechnika a informatika**  
Studijní obor: **Elektronika a aplikovaná informatika**  
Název tématu: **Návrh řídicí jednotky pro elektrickou pec**  
Zadávací katedra: **Katedra aplikované elektroniky a telekomunikací**

### Z á s a d y   p r o   v ý p r a c o v á n í :

1. Navrhněte systém řízení teplotních profilů v elektrické peci.
2. Navrhněte vhodný algoritmus pro regulaci teploty.
3. Zvažte možnosti využití fuzzy řízení systému.
4. Navržené řešení realizujte a diskutujte vlastnosti systému.

Rozsah grafických prací: **podle doporučení vedoucího**

Rozsah pracovní zprávy: **30 - 40 stran**

Forma zpracování diplomové práce: **tištěná/elektronická**

Seznam odborné literatury:

**Student si vhodnou literaturu vyhledá v dostupných pramenech podle doporučení vedoucího práce.**

Vedoucí diplomové práce:

**Ing. Kamil Kosturik, Ph.D.**

Katedra aplikované elektroniky a telekomunikací

Datum zadání diplomové práce: **14. října 2013**

Termín odevzdání diplomové práce: **12. května 2014**

Doc. Ing. Jiří Hammerbauer, Ph.D.  
děkan



Doc. Dr. Ing. Vjačeslav Georgiev  
vedoucí katedry

V Plzni dne 14. října 2013

# Anotace

*Bláha, Š. Návrh řídicí jednotky pro elektrickou pec. Katedra aplikované elektroniky a telekomunikací, Západočeská univerzita v Plzni - Fakulta elektrotechnická, 2014, 44 s., vedoucí: Ing Kamil Kosturik Ph.D.*

Cílem této diplomové práce je návrh a konstrukce řídicí jednotky pro elektrickou pec. Navržený systém využívá procesor AVR jako klíčový prvek. Společně s periferními integrovanými obvody tvoří malý ale výkonný řídicí systém pro použití v celé řadě tepelných procesů. Tato práce ukazuje kompletní řetězec designu, který začíná od konstrukce hardwarové části, pokračuje přes návrh softwarové části a završuje úvodním měřením a simulacemi. Celý návrhový řetězec poté končí u měření a testování regulačního algoritmu.

Motivace ke vzniku této práce vyšla ze snahy o propojení teoretických a praktických znalostí o systémech a jak lze tyto systémy regulovat.

## Klíčová slova

AVR, SSR, termočlánek, regulace, měření

# Assignment of diploma thesis

## Control unit for electric kiln

- Design a control system for electric kiln
- Design an algorithm for regulation of temperature
- Consider a usage of fuzzy control in the system
- Designed solution realize and discuss properties of the system

# Abstract

*Bláha, Š. Control unit for electric kiln. Department of applied electronics and telecommunications, University of West Bohemia in Pilsen - Faculty of Electrical Engineering, 2014, 44 s., supervisor: Ing Kamil Kosturik Ph.D.*

Aim of this diploma thesis is to design and build a control system for electric kiln. Proposed design uses low cost microprocessor AVR as a key element. Together with a peripheral integrated circuits it creates small but powerful control system with usage also in various temperature controlled processes. This thesis shows a complete chain of design. It starts from construction of hardware and software then it shows design of electric kiln controller, that is based on mathematical model. It ends with measurements and verifications of the regulation processes.

Motivation for this thesis comes from effort to interconnect a theoretical and practical knowledge about systems and how these systems can be regulated.

# Keywords

AVR, SSR, thermocouple, regulation, measurement

# Statement

I hereby submit for review and defense my diploma thesis, prepared at the end of study at the Faculty of Electrical Engineering University of West Bohemia.

I declare that I prepared this diploma thesis independently with usage of professional literature and resources listed in the list, which is part of this thesis. I also declare that all the software used to solve this thesis was obtained legally.

In Pilsen, June 30, 2014

Bc. Štěpán Bláha

.....

Signed

# Acknowledgements

First of all, I would like to thank to my family. To my parents, who always support me and who always give me what I needed. Without them none of this would be possible.

I would like to thank to Department of Applied Electronics and Telecommunications (FEE, UWB) for support during the work on this diploma thesis. Special thanks belong to my supervisor Ing. Kamil Kosturik Ph.D. who consulted with me on various topics. Special thanks also belong to doc.Ing. Josef Hrušák, CSc. who consulted with me many times and who gave me another look to problems I had at hand.

Last but not least, I would like to thank to my friend Matej, who read this manuscript and who gave me feedback during my work. Thank you!



# Contents

<b>List of Figures</b>	<b>viii</b>
<b>List of Symbols and Acronyms</b>	<b>x</b>
<b>1 Introduction</b>	<b>1</b>
1.1 Solid State Relay . . . . .	2
1.2 Thermocouple . . . . .	3
<b>2 Construction</b>	<b>4</b>
2.1 Development tools . . . . .	5
2.2 Hardware part . . . . .	5
2.2.1 Control unit . . . . .	5
2.2.2 Power supply unit . . . . .	6
2.2.3 Front panel . . . . .	7
2.2.4 Rotary encoder . . . . .	8
2.3 Software design . . . . .	9
2.3.1 Program . . . . .	9
<b>3 Simulation</b>	<b>12</b>
3.1 Initial measurement . . . . .	12
3.2 Transfer function and model . . . . .	13
3.3 Verification of the model . . . . .	14
<b>4 Regulation and Measurement</b>	<b>17</b>
4.1 Regulation methods . . . . .	17
4.2 Measurement . . . . .	17
4.3 Corrections . . . . .	21
<b>5 Conclusion</b>	<b>22</b>

**Bibliography** **24**

**Appendices** **25**

**A Circuit diagrams** **25**

    A.1 Regulator . . . . . 25

    A.2 Power supply . . . . . 25

    A.3 Display and keyboard panel . . . . . 25

    A.4 Rotary encoder . . . . . 25

**B Photos** **32**

# List of Figures

- 1.1 Electric kiln . . . . . 1
- 1.2 Solid State Relay (SSR) [1] . . . . . 2
- 1.3 Thermocouple [2] . . . . . 3
  
- 2.1 Block diagram . . . . . 4
- 2.2 Toolchain . . . . . 5
- 2.3 Control unit . . . . . 5
- 2.4 Power supply block diagram . . . . . 6
- 2.5 Load regulation . . . . . 7
- 2.6 Front panel . . . . . 8
- 2.7 Encoder output [3] . . . . . 8
- 2.8 Flowchart . . . . . 10
  
- 3.1 Heating . . . . . 13
- 3.2 Heating and cooling . . . . . 13
- 3.3 Simulation model . . . . . 14
- 3.4 Low temperature regulation . . . . . 15
- 3.5 Complete thermal cycle . . . . . 15
- 3.6 Simulation error . . . . . 16
  
- 4.1 2-State Regulation . . . . . 18
- 4.2 Regulation 1 . . . . . 18
- 4.3 Regulation 2 . . . . . 19
- 4.4 Regulation 3 . . . . . 20
- 4.5 Comparison of regulations . . . . . 20
- 4.6 Corrections . . . . . 21
  
- B.1 PCB of Regulator . . . . . 32
- B.2 PCB of Power supply . . . . . 33

B.3	PCB of Rotary Encoder . . . . .	33
B.4	PCB of Panel . . . . .	34
B.5	PCB of Panel - 2 . . . . .	34

# List of Symbols and Acronyms

SSR	Solid State Relay
AC	Alternating Current
DC	Direct Current
VAC	Voltage in Alternating Current
VDC	Voltage in Direct Current
IDE	Integrated Development Enviroment
ISP	In-System Programming
RTC	Real Time Clock
SPI	Serial Peripheral Interface
LCD	Liquid-Crystal Display
I <sup>2</sup> C	Inter-Integrated Circuit
PCB	Printed Circuit Board
LED	Light Emitting Diode
CW	Clockwise
CCW	Counter Clockwise
PWM	Pulse Width Modulation

# 1

## Introduction

At the begin of this thesis an introduction will point out basic parts of electric kiln. In the following chapters there will be described a hardware design of control unit, software part with regulation algorithm and at the end there will be simulations and measurements done for testing and calibration of regulation process.

Let's begin with a simple question. What is an electric kiln? It is a basic question, but someone maybe doesn't know the answer. Any kind of kiln (not only electric) is used to heat up small inner space (thermally insulated chamber) to some certain temperature and then it should keep this temperature for some given time. The electric kiln is a type of kiln, which uses electric energy to heat up. This type of kiln has insulated chamber inside with atmosphere rich on oxygen. It is because there is no open flame to consume oxygen molecules. The atmosphere inside the insulated chamber can be also donated with some additional gas, but it depends on usage of electric kiln.

In our further development we will focus only on the temperature inside insulated chamber and not on the atmosphere inside it.



Figure 1.1: Electric kiln

From electric point of view, most of the small electric kilns are powered by single phase electric power. But also there are some areas, where 3-phase electric power can be used (mostly in industry). This depends on the power of electric kiln. For more technical details about

electric kiln used in this project, you can see table below (1.1), where you can find essential parameters of the kiln.

Table 1.1: Device parameters

Model	L9R	Power	2.7kW
Company	Nabertherm	Voltage	220V/50Hz
Dimension	52 x 42 x 54 cm	$T_{max}$	1100°C

To control electric kiln you need two parts - sensor for temperature measurement and regulatory element for power coming to heater. As sensor of temperature it is used a termocouple and as regulatory element it is used SSR (Solid State Relay). Both parts are shortly described in following sections.

## 1.1 Solid State Relay

A Solid State Relay or shortly SSR is an electronic device used for switching large power incoming into the load. Switching is done by applying external voltage on the input of SSR. Control signal can be either AC or DC. It depends on type of relay. Basic structure of SSR consist of 3 parts - first is sensor for input control signal, second part works as a switch of load and third part couples previous parts together (electrically insulated). SSR has the same function as electromechanical relay, but it is without any moving parts. One of the advantages of SSR is that it is faster than standard electromechanical relay. On the other hand one of the disadvantages of SSR is that it has voltage and current characteristics of semiconductor rather than mechanical contacts [4].



Figure 1.2: Solid State Relay (SSR) [1]

For more technical details about SSR used in this project you can see datasheet [1], where you can find all parameters of SSR D2425 used inside the electric kiln. The most important parameters are mentioned in table below (1.2).

Table 1.2: SSR parameters

Control Voltage	3-32VDC	Operating Voltage	24-280Vrms
Max. Input Current	12mA	Max. Load Current	25A
Min. Turn-On Voltage	3VDC	Dielectric Strength	4000Vrms

## 1.2 Thermocouple

A thermocouple is device used for measuring temperature. It consists of 2 different types of conductors with connection of each other at one or more points. The basic principle of thermocouple is that it produces a small voltage at the output, which is proportional to temperature difference between one end and reference point. This process is called thermoelectric effect [5].

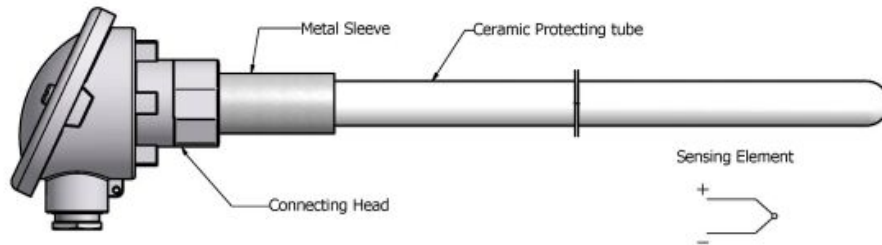


Figure 1.3: Thermocouple [2]

The types of conductors used for thermocouple determines a temperature range and characteristic functions of thermocouple. You can find some parameters in table below (1.3).

Table 1.3: Thermocouple comparison [5]

Type	Range	Sensitivity	Material
K	-200°C to +1250°C	41 $\mu$ V/°C	chromel - alumel
J	-40°C to +750°C	50 $\mu$ V/°C	iron - constantan
E	-50°C to +740°C	68 $\mu$ V/°C	chromel - constantan
T	-200°C to +350°C	43 $\mu$ V/°C	copper - constantan

Inside an electric kiln there is installed a thermocouple of type K with range that is sufficient to the usage of kiln. In our case a thermocouple has a ceramic protection tube because it is placed inside chamber of kiln.

Following chapter gives details about design and construction of control unit for electric kiln.



# 2

## Construction

This chapter is going to describe design and construction of control unit for electric kiln. First of all it will provide general idea of design and then it will point out each part separately with description of electronic circuit, at hand. Also it will shortly describe tools used for design.

In the figure below (2.1) you can see a complete block diagram of the control system. As you can see, the control system is divided into four main parts. The blue part represents electric kiln with VAC input, SSR and own insulated chamber with a thermocouple of type K. The base part of control system is power supply unit which uses VAC input from electric kiln and generates output DC voltage for all remaining parts. The most important part is control unit block, which contains processor unit and interfaces to electric kiln. Two remaining parts are front panel and rotary encoder. These two blocks constitute user interface, which enables a user to set desired temperature level.

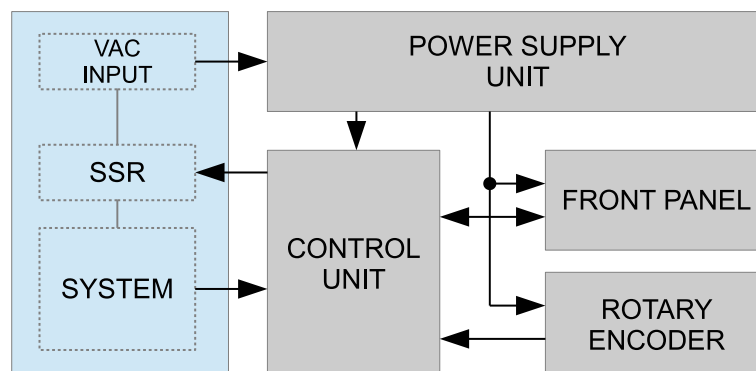


Figure 2.1: Block diagram

## 2.1 Development tools

A few useful tools, that help with the design, was used for this project. A program CadSoft Eagle 6.4 was used for design of circuit diagrams and following PCB designs. Since the Atmel AVR processor was used, intergrated development enviroment (IDE) Atmel Studio 6.1 was selected for design of software part. In the figure below (2.2) you can see the toolchain. It shows connection of IDE and development board with AVR processor. Connection is done by ISP programmer Atmel AVRISP mkII.

Matlab/Simulink R2011a was used for processing of measured data and simulation of regulation process.

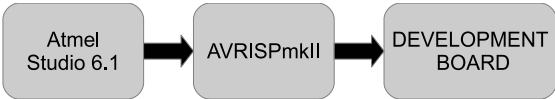


Figure 2.2: Toolchain

## 2.2 Hardware part

In this section you will find a description of each part of a control system. You can find actual circuit diagrams in the appendix A and in the appendix B there are a photos of completed device.

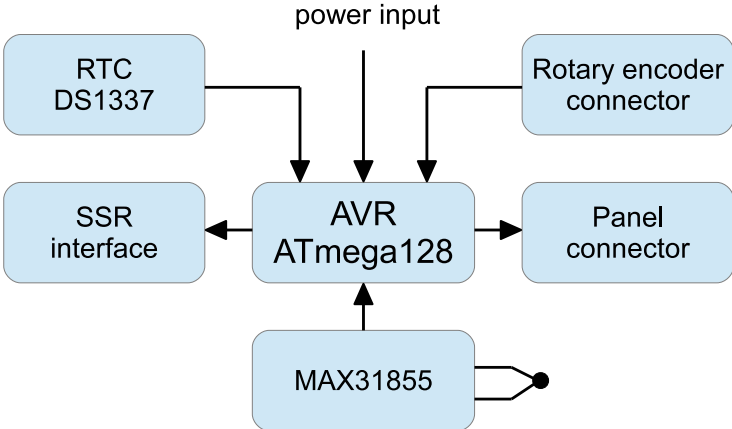


Figure 2.3: Control unit

### 2.2.1 Control unit

As was said before, a control unit is the most important part of the whole system. It represents a bridge between the user and electric kiln. Control unit has to interpret a commands from user and also it has to generate a proper signals for electric kiln according to the user commands.

From the figure below (2.3) you can see a detail structure of control unit. It consist of processor Atmel AVR Atmega128 [6] as main computational unit, integrated circuit MAX31855 [7] as a digital converter for thermocouple, integrated circuit DS1337 [8] as RTC source unit, and finally interfaces for user and SSR.

The AVR processor communicates with digital converter MAX31855 via SPI. The converter sends to processor a data packet which consists of cold-junction compensated value of temperature measured with usage of thermocouple. The processor generates output control signals for SSR according to temperature user setting and used controller.

The AVR processor also generates a control signals for graphical LCD, which is connected to the control unit via panel connector. Through this connector the processor also receives input signals from small keyboard. You can find more about graphical LCD and keyboard in the section about front panel.

Second connector, which brings input signals from user to processor, is connector for rotary encoder. The main purpose of the rotary encoder is that it enables user to easily set desired value of temperature for electric kiln.

Last part of control unit is RTC block which consists of integrated circuit DS1337. It is a low power circuit which provides clock and calendar data over I<sup>2</sup>C bus. This gives user more possibilities to interact with the system for example by setting a timer to switch on the kiln at given day and hour. The RTC block doesn't effect the regulation process and it is an additional part.

### 2.2.2 Power supply unit

The power supply unit provides supply voltage for all parts of the control hardware. It is designed as a linear regulated power supply with 2 levels of output voltage - 3.3V and 5V. The power supply uses VAC (230V) from the electric kiln as input. In the figure below (2.4) you can see the structure of the power supply unit.

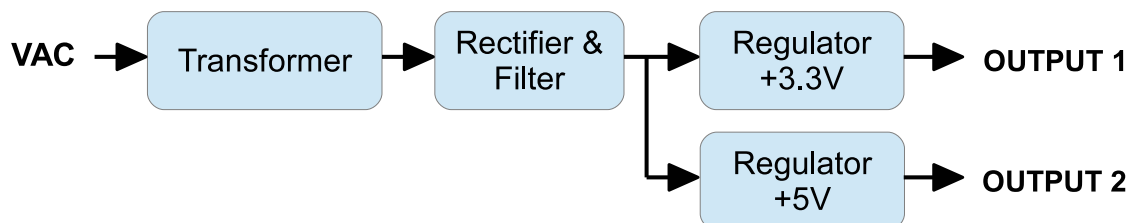


Figure 2.4: Power supply block diagram

Transformer alters 230 VAC input to 9 VAC output. This output voltage is transformed via rectifier and filter to the output DC voltage through 2 following voltage regulators. The first one is for +3.3V with maximum current up to 1A. It provides a supply voltage for control unit and all integrated circuits. The second regulator is for +5V branch with current up to 1A. It provides a supply voltage for a graphical LCD drivers.

Following equation shows calculation, which determines a value of filter capacitor.

$$U_{max} = U_{sek} - 2U_d = 9 - 1 = 8V$$

$$U_{min} = U_{out} + \Delta U = 5 + 0.5 = 5.5V$$

$$C \geq \frac{I \cdot \arccos\left(\frac{-U_{min}}{U_{max}}\right)}{2 \cdot \pi \cdot f (U_{max} - U_{min})} = \frac{1.5 \cdot \arccos\left(\frac{-5.5}{8}\right)}{2 \cdot \pi \cdot 50 \cdot (8 - 5.5)} = 4.4mF \doteq 4.7mF$$

As a regulator for the first +3.3V level was used a low drop (LDO) integrated circuit LF33CV [9] with load regulation about 50mV over 1A range. For the second +5V level was used LDO integrated circuit LM2940CT-5 [10] with load regulation about 150mV over 1A range.

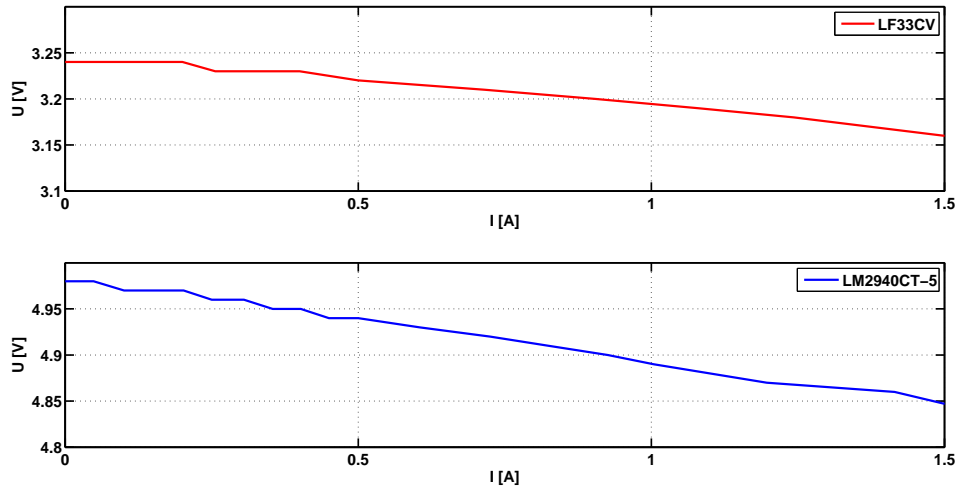


Figure 2.5: Load regulation

### 2.2.3 Front panel

The front panel constitutes user interface. It consists of small keyboard - set of 3 buttons, graphical LCD and signalization LED diode. It allows user to see current state of the electric

kiln and also to change settings via panel. Signalization diode is used for visualization of the state of the regulation.

The front panel has its own PCB as it is apart from the control unit (because of the position of the mount hole inside the rack of the electric kiln). The panel is connected to the control unit via 26-pin connector. It connects supply voltage and all necessary signals for the graphical LCD and buttons.

Front panel electronics is made of of 2 PCBs. The first PCB is graphical LCD itself and via its connector it is connected to the PCB with buttons and signalization LED diode. You can see a detail configuration in the figure below (2.6) and also in appendix B - Photos.

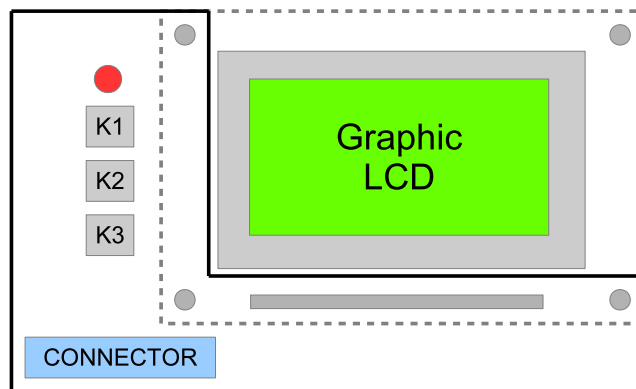


Figure 2.6: Front panel

## 2.2.4 Rotary encoder

The rotary encoder is part of a user interface. It allows user to set desired value of temperature only by rotation of the shaft. It can be also used as a replacement for full numerical keyboard.

Principle of the rotary encoder is that it works like 2 independent switches. Each one of them connects input voltage to the ground, when it is switched on. Ideal shape and phase of the signals coming out from the rotary encoder is shown in the figure below (2.7). Both channels of rotary encoder has RC filters to ensure a detection and reduce a noise in signals coming from rotary encoder to the processor.

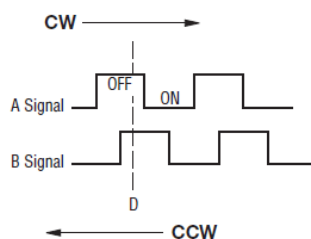


Figure 2.7: Encoder output [3]

Type PEC11-4220F-S0024 [3] from Bourns Inc was used as a rotary encoder. It's a compact rotary encoder with 24 pulses per 360° and it has additional switch on the shaft, which can be used for confirmation of selected value or for changing the speed of incrementation/decrementation.

The rotary encoder has its own PCB and it is separated from the front panel, because of the position of the mount hole inside the rack of the electric kiln.

## 2.3 Software design

In this section you will find a description of the software used in the control unit. As was said before the Atmel AVR processor was used for a control. Along with it the Atmel Studio 6.1 was used as IDE to write the software.

The software is important as well as the hardware. It has to manage all necessary parts of the control system including graphical LCD, buttons from user interface and, last but not least, regulation algorithm.

In the following section you will find a detail description of the program running in the control unit.

### 2.3.1 Program

The best way, how to describe a structure of program is through a flowchart. In figure (2.8) you can see a flowchart of the program running in control unit.

On the left side of the flowchart you can see a diagram of the main function. On the right side of the flowchart you can see blocks, that represent interrupt routines used in the program. It used two basic types of interrupts. The first one is external interrupt used for catching unpredictable events from user (mainly from buttons). The second type of interrupt is interrupt from timer overflow. This is used to manage a periodical events like sending of measured data to the superior device (PC) or creating a PWM signal for driving of SSR.

From the flowchart of main function ( left side of figure 2.8) you can see principal blocks and structure of the program. The first three blocks do initialization, enable interrupts and setup graphical output for user via graphic LCD. The drivers for graphic LCD are based on GNU AVR library for KS108 driver. All necessary files are linked in Atmel Studio project.

After initialization it follows with infinite loop that consists of routine for communication

with MAX31855 (temperature measurement), routines for updating graphic LCD and finally with regulation that sets SSR for heating.

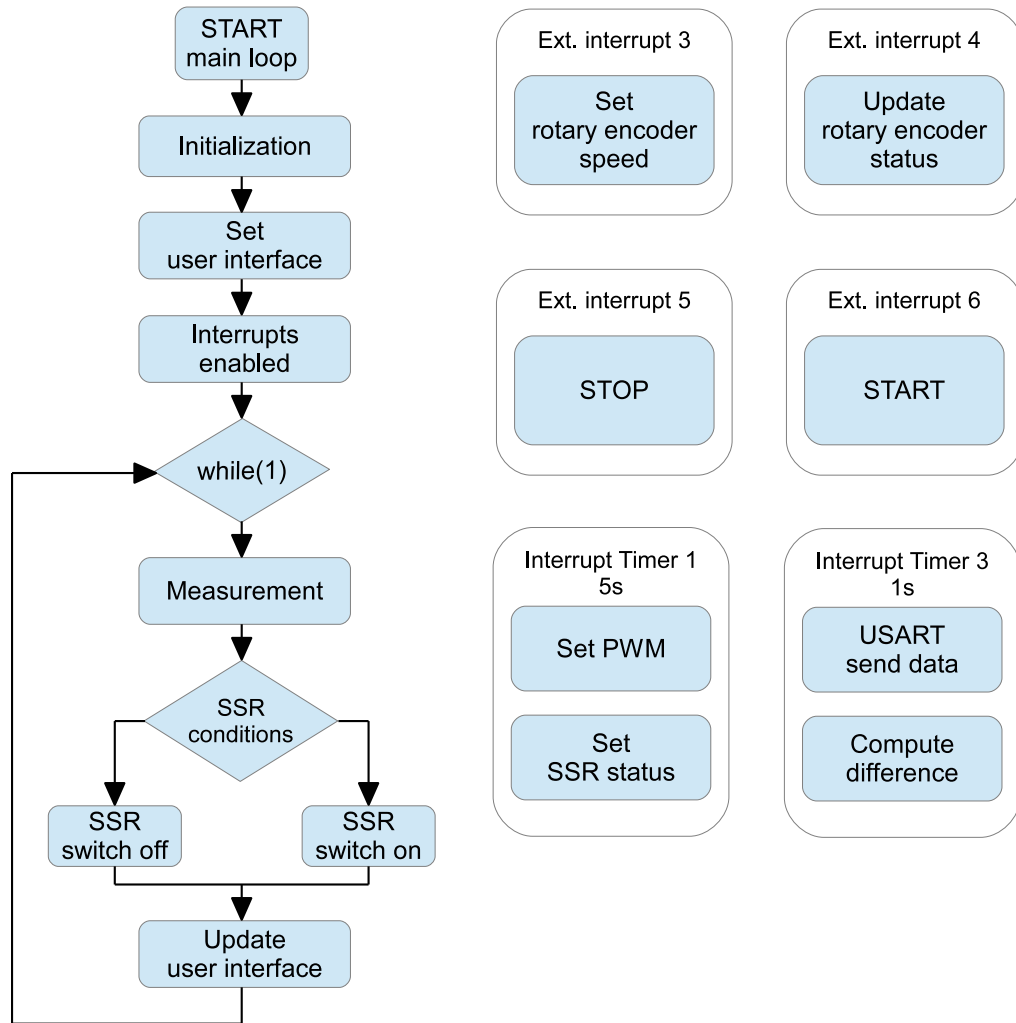


Figure 2.8: Flowchart

As was said before, two types of interrupts were used for six interrupt routines (right side of 2.8). First type is external interrupt that was used four times for user interface (which include main stop and start buttons). External interrupt is also used for detection of event at rotary encoder. Principle is based on hardware function of rotary encoder. An external interrupt is connected to one channel of this encoder. When the interrupt happens, interrupt routine checks value on the second channel of the rotary encoder. This defines direction of detected rotation.

Second type of interrupt is interrupt from timer overflow that was used two times. First interrupt from timer overflow has a period 1 second and it is used for sending measured data to the superior device (PC, Raspberry PI) through serial link. It also computes difference of measured values in range of 10 seconds. This gives an information about a progress of measured state. Second interrupt from timer overflow has period 5 seconds and it's used for setting a

duty cycle of PWM and for updating SSR status. The period of PWM is 20 seconds according to the response of the electric kiln to the input power signal.

The regulation conditions are based on simulation and initial measurements. The first condition switches from 100% to 50% duty cycle of PWM at 90°C below desired temperature. The second condition completely switches off the power to the system at 15°C below a desired level. For both of these two condition the progress of temperature has to be positive (temperature is rising). The third condition is for switching on the power to the system. It's done when the progress of temperature is negative (temperature is descending) and actual level is 2°C below a desired level.

You can find a results of the regulation algorithm in the following texts.



# 3

## Simulation

This chapter is going to describe simulation of the electric kiln in Matlab/Simulink environment. First step when developing simulation model was based on initial measurements of the system. After these measurements it was possible to make approximations of system behavior with analytical approach (with usage of system transfer functions).

### 3.1 Initial measurement

In the figure (3.1) you can see an initial measurements for 100%, 75% and 50% of PWM duty cycle. From results it's clearly seen a different time for heat up at the temperature 1000°C. The shortest time of heat up is around 85 minutes with 100% of PWM duty cycle. With 50% of PWM duty cycle it takes more than two times to get to 1000°C. Cooling of the system was also measured, which can be seen in the figure (3.2). The cooling of the system from 1000°C takes more than 23 hours with closed door of kiln chamber. The time of cooling is so long because of a good heat accumulation of ceramic material and missing active cooling system in electric kiln.

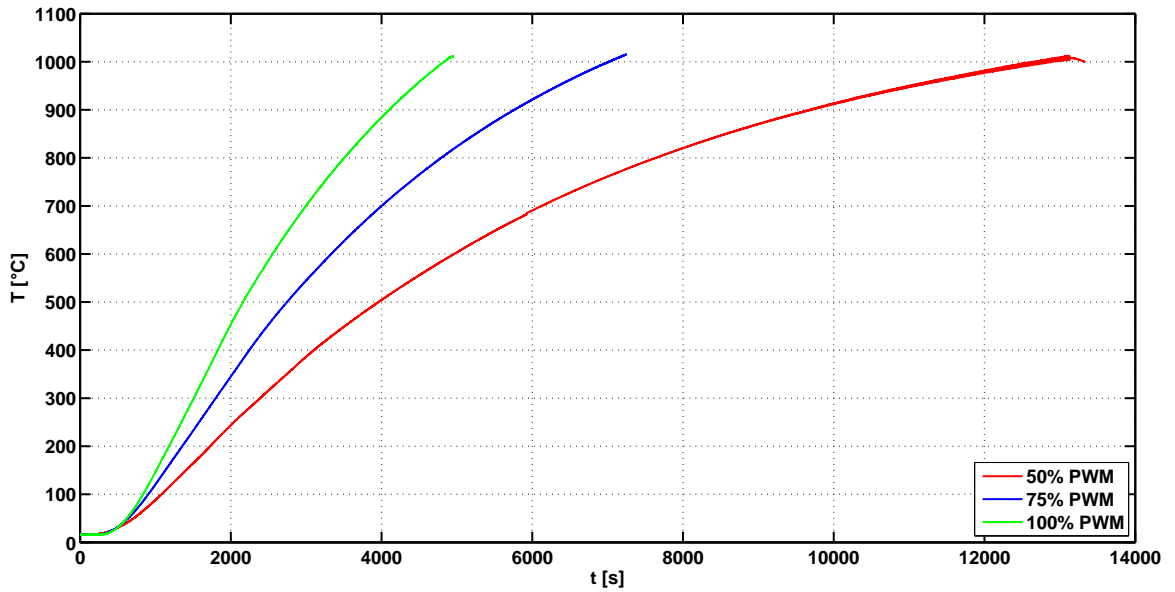


Figure 3.1: Heating

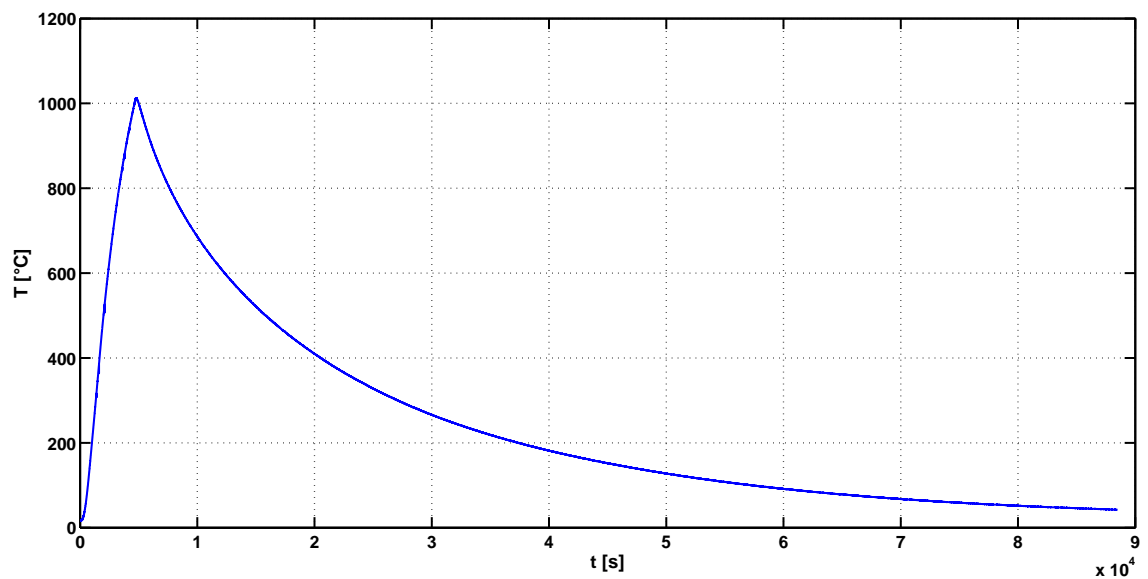


Figure 3.2: Heating and cooling

## 3.2 Transfer function and model

In the figure (3.3) you can see complete representation of the simulation model. It consists of several parts, but the most important parts are gray and yellow. A yellow part is 100 seconds long transport delay, which represents delayed reaction of the system. A gray parts are blocks of transfer functions connected in series. Both transfer functions are first order systems. Together

they create a second order system, which represents a reaction of the electric kiln on input power signal. The first transfer function represents heating up and the second one represents cooling of the system. The following orange parts only restore regular value of temperature from the output of the transfer functions. It's due to the missing information about initial temperature and maximum range. A green blocks at the begin and at the end of the simulation model are links to workspace of Matlab enviroment. Input green block R brings to the model information about the state of SSR (if it's switch on/off). The range of this signal is between 0 and 1 and sample time is 1s. Output green block T\_sim transfers simulation results into the workspace for further processing to the graphs with real measured data as you can see in the following section.

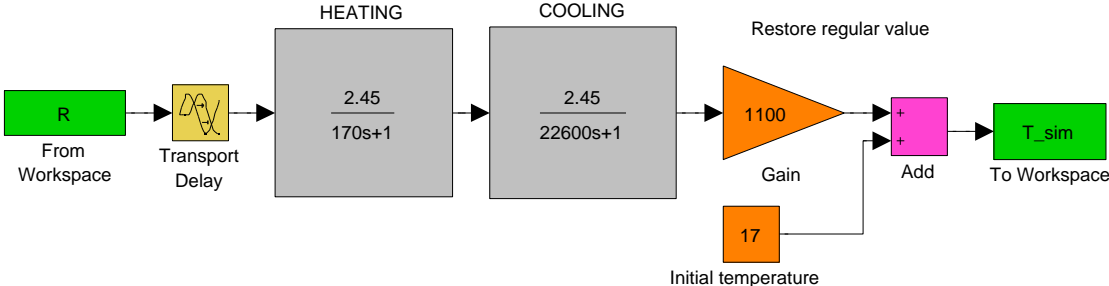


Figure 3.3: Simulation model

### 3.3 Verification of the model

The simulation model of the electric kiln was verified with real measurements. The first comparison was done at low temperature regulation process. As you can see from figure (3.4), the results of simulation are similar. Slight difference is due to the approximation of the system so that simulation is slightly faster than real measured data.

Figure 3.4: Low temperature regulation

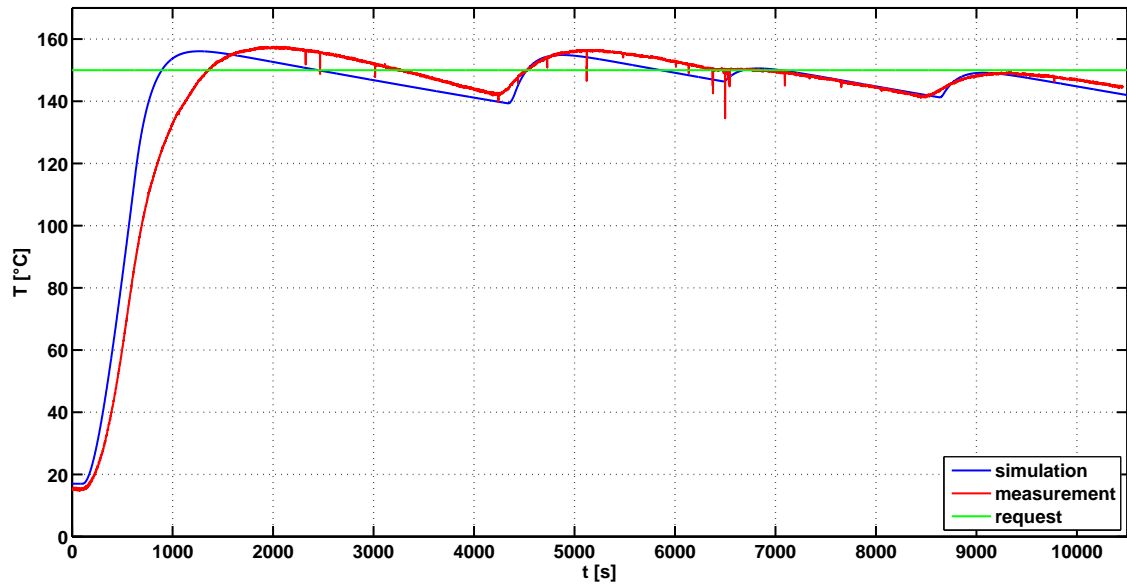
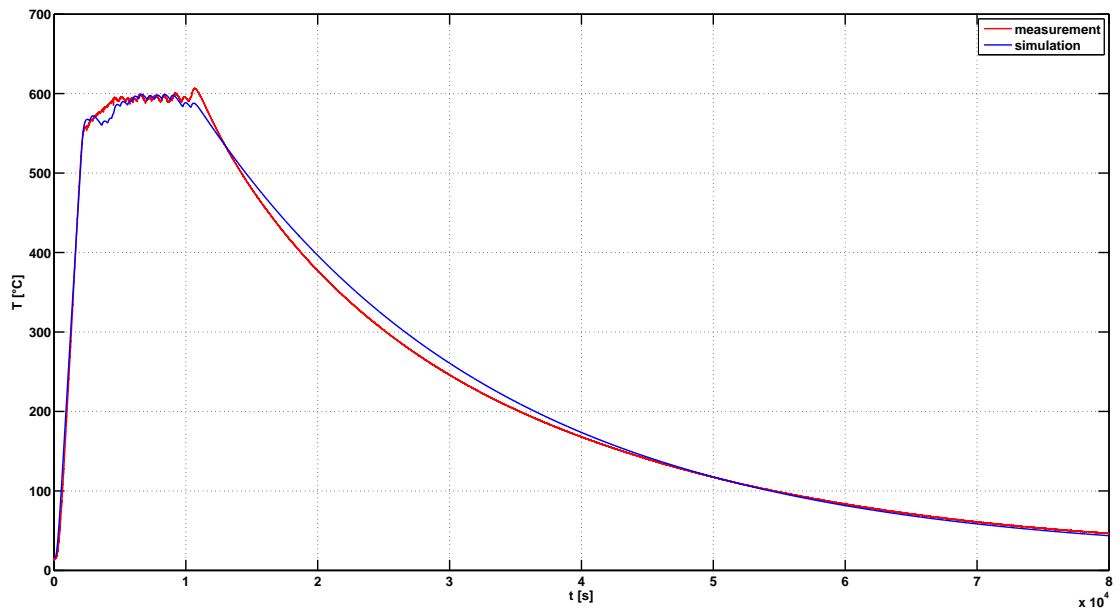


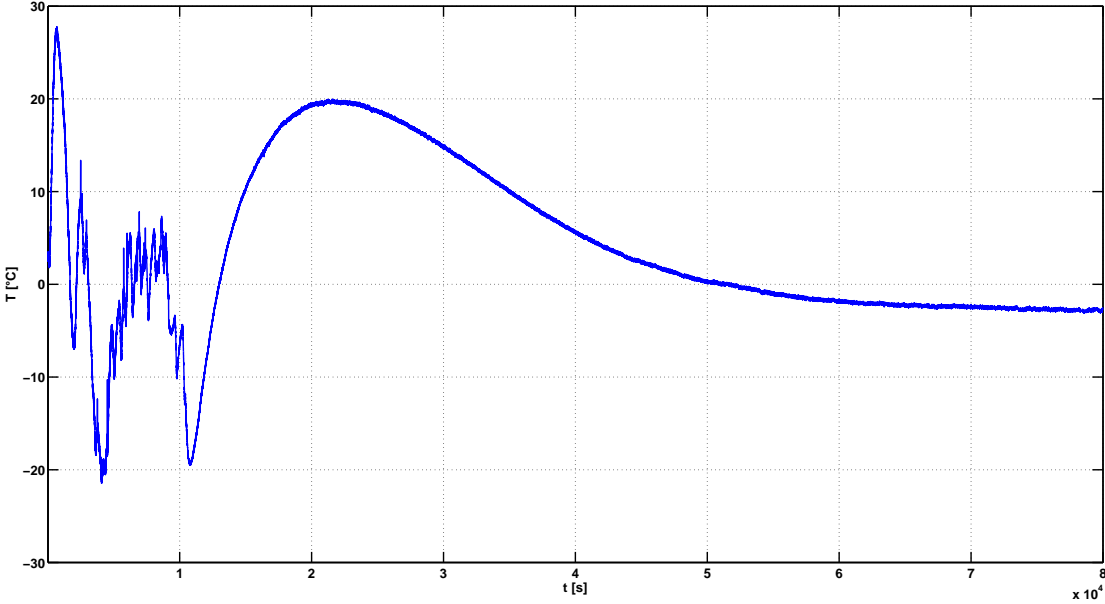
Figure 3.5: Complete thermal cycle



On figure (3.5) you can see complete thermal cycle. The complete thermal cycle was measured with control unit and Raspberry Pi (used as a data logger). Raspberry Pi [11] was used, because of the abnormally long time of measurement (due to the cooling of the electric kiln). As you can see, the results of simulation has relatively small difference from a measured data. This is due to the approximations applied on the rising and descending edge (heat up and cooling).

On figure (3.6) you can see difference (error) between simulation results and measurement. The highest difference is around 28°C and mean of the error is 3.92°C.

Figure 3.6: Simulation error



# 4

## Regulation and Measurement

This chapter contains description of regulation and results of measurement with control unit installed in the rack of electric kiln.

### 4.1 Regulation methods

Results from simulation and initial measurements were used for setting and tuning of the regulation process. Regulation is based on 2 basic methods.

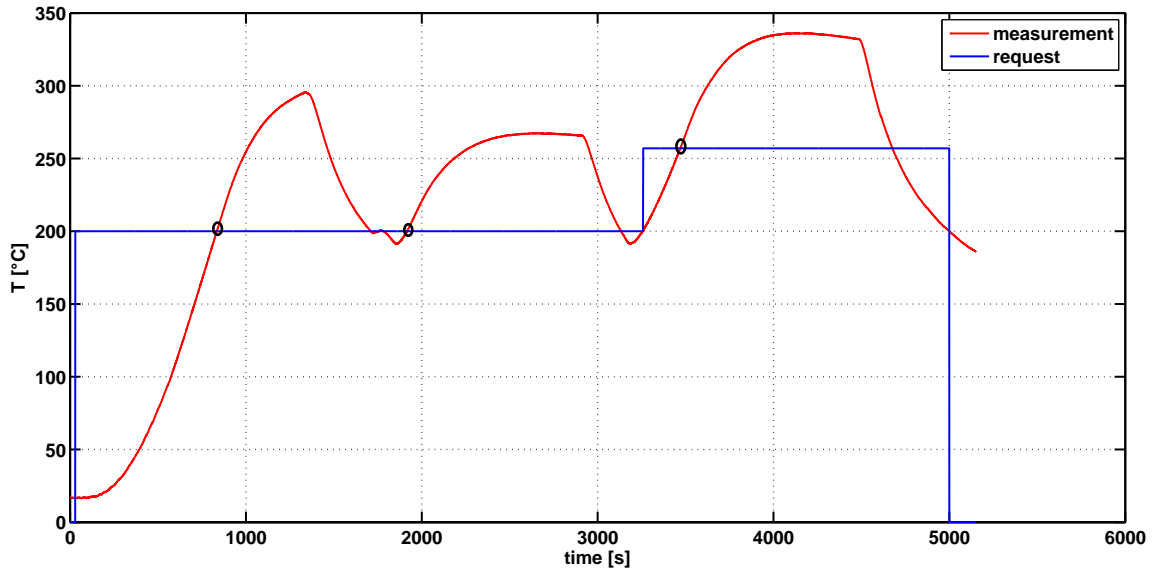
The first type of a regulation method is based on principle of 2-State regulation. It switches off incoming power to the system before reaching a desired level of temperature. After this a temperature of the system increase due to the dynamics of the system. When a temperature is in the close neighborhood around desired value, the control system checks progress of temperature and according to the direction of the progress it switches power to the system again.

The second regulation method is based on the first one. The only change from the first one is that it uses a PWM to get faster (and with minimal overshoot) into the close neighborhood of a desired value. Also the regulation conditions inside the region of desired value are more strict. Both of these improvements have impact on the results of regulation. In the following section you can see a given results.

### 4.2 Measurement

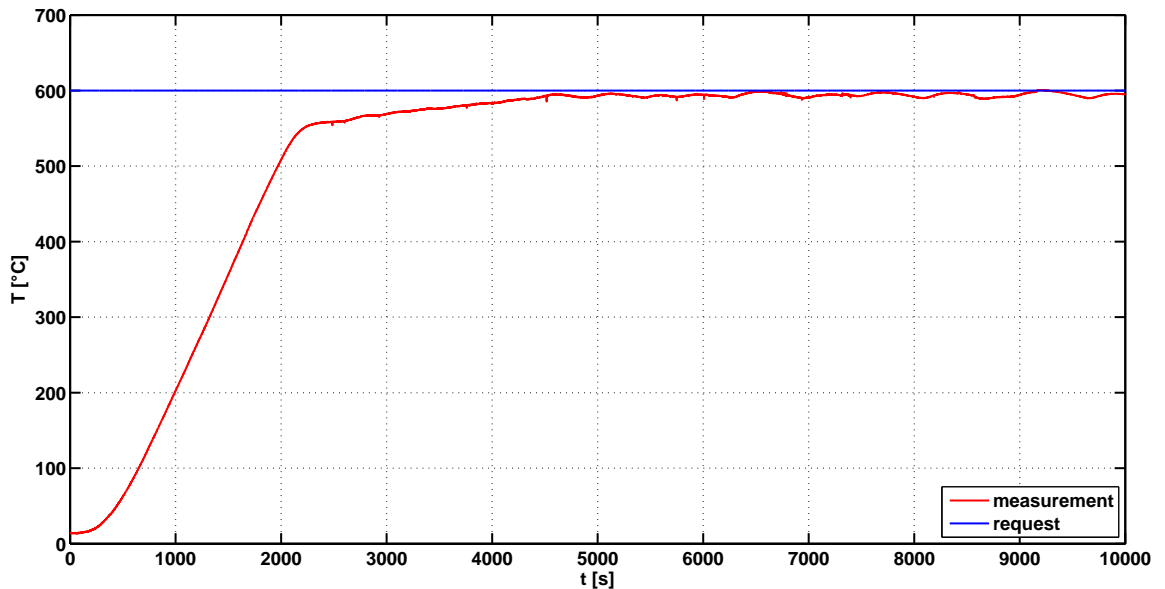
In the figure (4.1) you can see results of the initial tests. It's a simple 2-State regulation with power on/off condition set precisely at the requested value of temperature (it's marked by black dots). It's clear that this is not sufficient regulation, because of the overshooting.

Figure 4.1: 2-State Regulation



In the figure (4.2) you can see result of the first regulation method as it was described in previous section. This regulation method works without any overshoots, but it's slow. It takes about 80 minutes to get close to the desired value of temperature. Also the oscillations around desired value are high (more than  $\pm 6^{\circ}\text{C}$ ).

Figure 4.2: Regulation 1



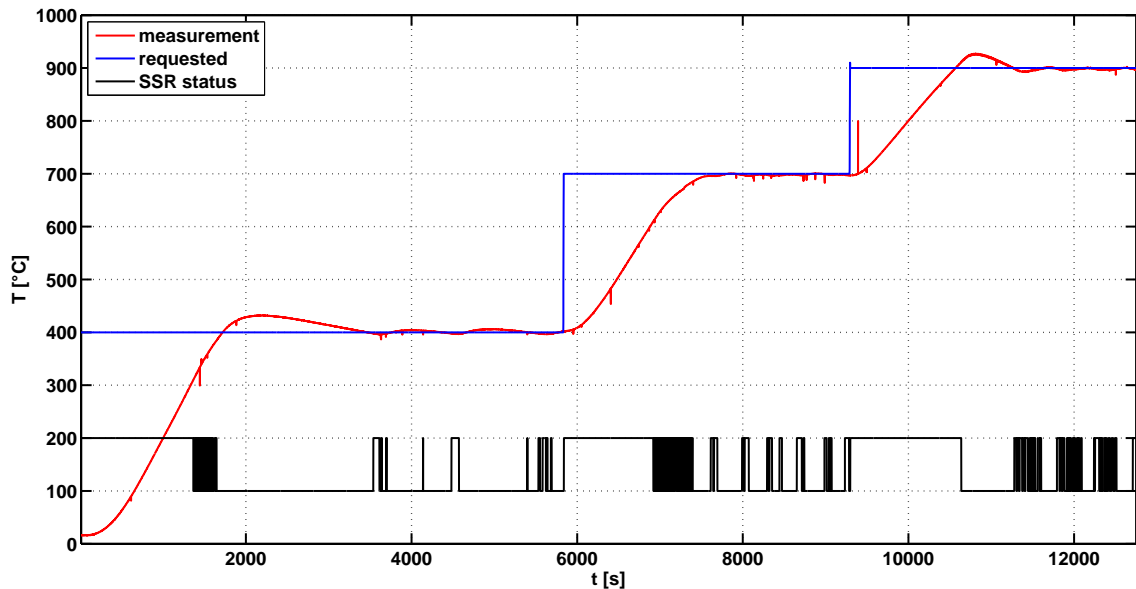
The next 2 following figures (4.3 and 4.4) shows the regulation cycles which use the second regulation method. The figure (4.3) shows regulation on 3 different levels of temperature ( $400^{\circ}\text{C}$ ,  $700^{\circ}\text{C}$  and  $900^{\circ}\text{C}$ ). Together with measured temperature from electric kiln you can

see a state of SSR (if it's switch on/off). At the beginning of the regulation process goes on maximum power. In the close neighborhood around desired value SSR gives only a 50% of power via PWM.

As you can see in the figure (4.3), regulation process overshoots at low temperature (under 500°C) with magnitude of 30°C (less than 10% from the range). At the high temperature level a regulation process overshoots with magnitude of 25°C. The oscillations around desired value are constant ( $\pm 4^\circ\text{C}$ ).

The first overshoot of desired value with magnitude up to 30°C is acceptable according to planned usage of the electric kiln. According to the usage more important is that regulation system is capable of holding a desired value with a minimal oscillations around this value.

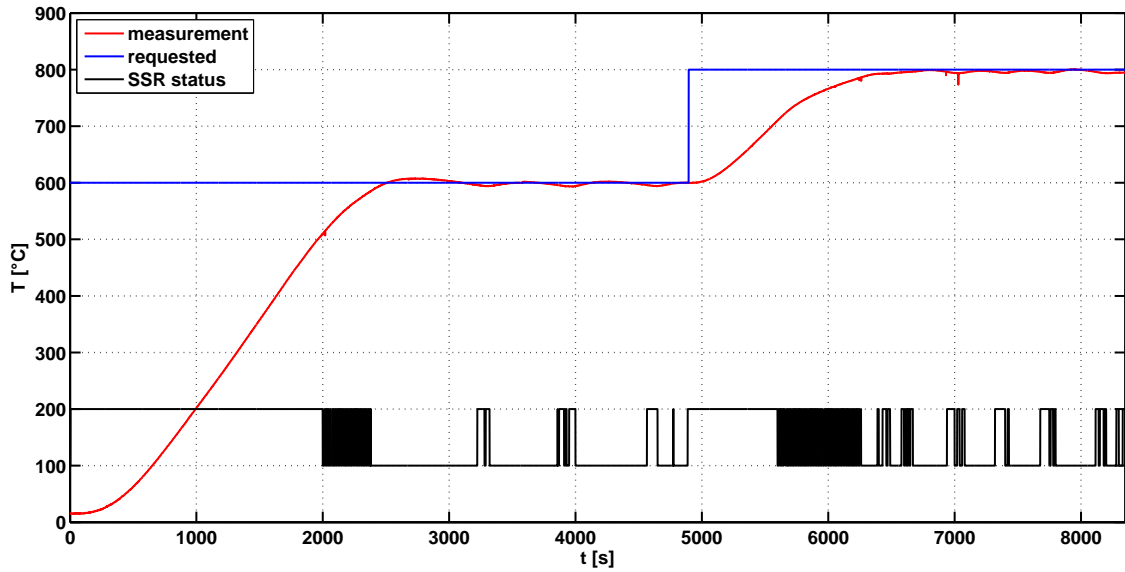
Figure 4.3: Regulation 2



The figure (4.4) shows a regulation on 2 different levels of temperature (600°C and 800°C) together with a state of SSR. From the figures (4.3 and 4.4) you can see, that the regulation process works without overshoot in temperature range from 500°C to 900°C, where dynamics of the system are different from dynamics on low temperatures.

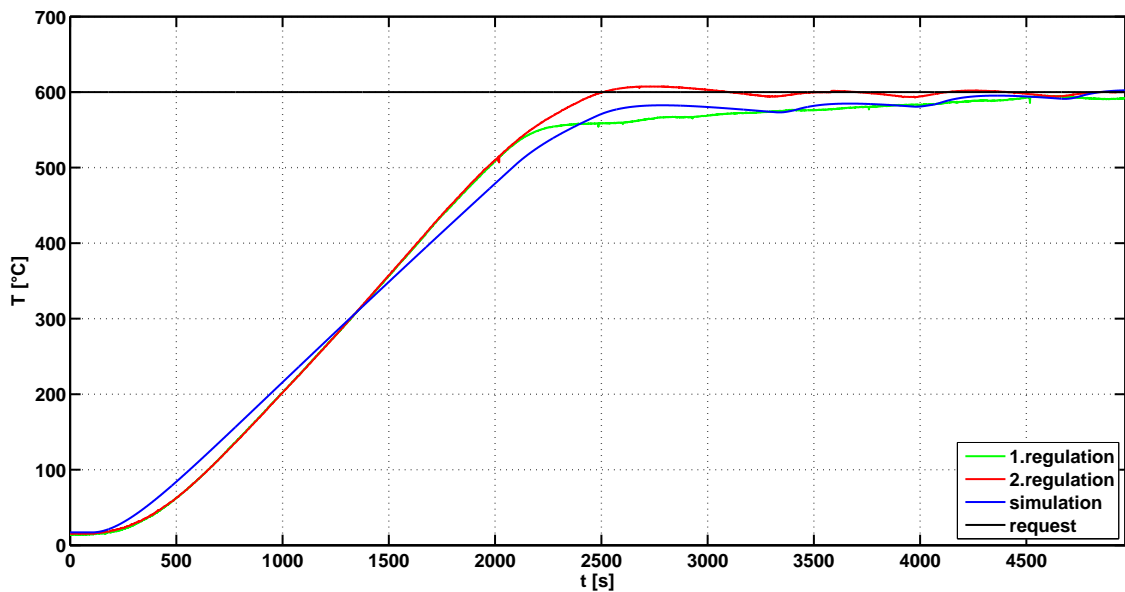


Figure 4.4: Regulation 3



In figure (4.5) you can see comparison of two measured regulations. A comparison is made for regulation on temperature  $600^{\circ}\text{C}$ . It is shown together with output results from Matlab simulation model. The first type of regulation is much slower than the second one, which uses a PWM in the close neighbourhood around desired value. The output simulation is between the first and second type of regulation. The regulation process is faster with the second type of regulation but it has a small overshoot around  $7^{\circ}\text{C}$ . The average oscillations of this fast regulation are  $4^{\circ}\text{C}$ .

Figure 4.5: Comparison of regulations

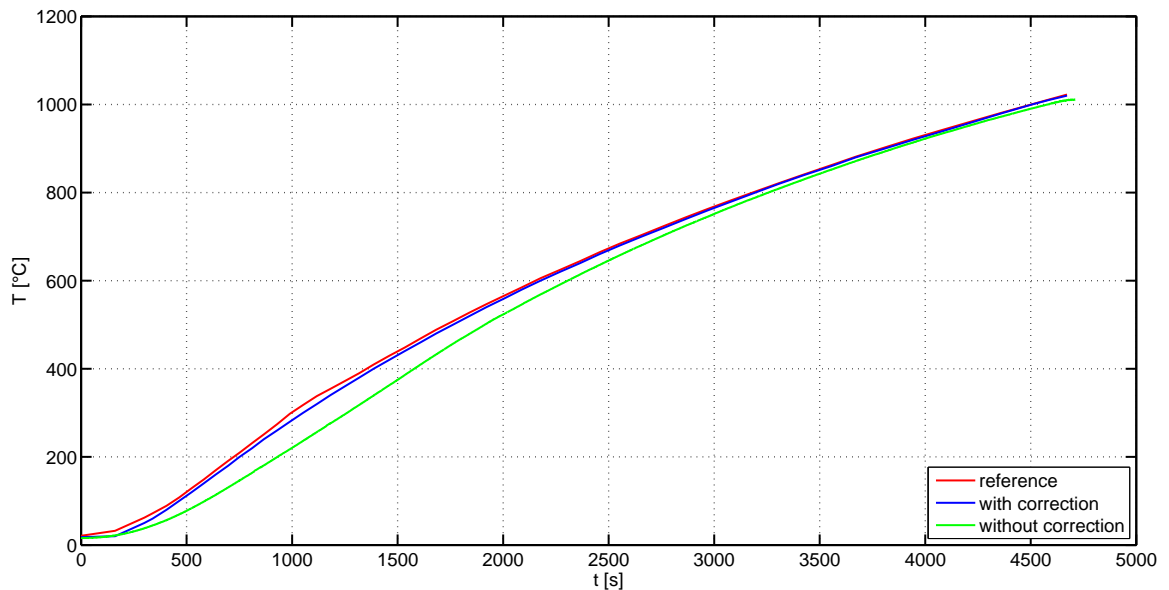


## 4.3 Corrections

This section shows measurement of temperature corrections. It was done by applying of an external thermometer to the chamber of electric kiln and measuring a temperature at same process as internal thermometer. The reference measurement was done by external thermometer Almemo 2290-4 with a thermocouple of type K. In the figure (4.6) below you can see a comparison of measurements with and without applied corrections.

The largest difference between the reference measurement and measurement without correction is  $80^{\circ}\text{C}$  at the range from  $100^{\circ}\text{C}$  to  $600^{\circ}\text{C}$ . From  $600^{\circ}\text{C}$  up to  $1000^{\circ}\text{C}$  the difference decreases to  $20^{\circ}\text{C}$  as a minimum. At the room temperature the difference is around  $4^{\circ}\text{C}$  between the reference and uncorrected values. The correction values from this measurement were processed with Matlab environment and as lookup table they were inserted into the control algorithm.

Figure 4.6: Corrections



# 5

## Conclusion

This chapter sums up all results and discuss parameters of regulation and suggest possible improvements for control unit.

As you can see from the previous chapters, the regulation performance is acceptable according to the range of temperature we are working with and usage of the electric kiln. The overshoots are less than 8% from the range at extra low and extra high temperatures. In range between 500°C and 800°C the regulation is without overshoots. Temperature oscillations are less than 1% from the range. Speed of temperature increment is about 16°C/minute at maximum power. With less power a speed of temperature increment decreases linearly. A temperature increment is about 10°C/minute at 50% of power.

The results of simulation are proportional to the measured data from real system of electric kiln. A slight difference between a simulation results and measured data is due to the approximation of the real system by mathematical model. Despite of differences in simulation and measurements mathematical model can be used for simulation of more sophisticated regulation methods like adaptive PID regulation or Fuzzy regulation.

Now at this point it is time to suggest a few possible improvements or modifications. The first improvement can be in the regulation algorithm. It can be replaced by PID regulation for example or by implementation of different type of regulator. A different type of regulation was not tested because of the sufficient results of used method. But hardware part of control system is capable of implementation every regulation method that can be represent in C programming language. This means that new regulator is only matter of modification of software without any changes in hardware.

The second improvement can be in user interface. It's possible to use another type of graphic

LCD or buttons or even it's possible to use a graphic LCD with touchscreen. This can improve a level of user comfort.

Without any improvements this designed control system gives a sufficient performance to control an electric kiln and also it makes a base for further development with this control system.

# Bibliography

- [1] I. Crydom, “Datasheet d2425.” [http://www.crydom.com/en/products/catalog/s\\_1.pdf](http://www.crydom.com/en/products/catalog/s_1.pdf), 2013.
- [2] F. Correge, “Industrial thermocouple.” <http://www.correge.fr/industrial-thermocouple-sensor-ceramic-protector.html>, 2014.
- [3] I. Bourns, “Datasheet pec11r.” <http://www.bourns.com/data/global/pdfs/PEC11R.pdf>, 2014.
- [4] I. Wikimedia Foundation, “Solid state relay.” [https://en.wikipedia.org/wiki/Solid-state\\_relay](https://en.wikipedia.org/wiki/Solid-state_relay), 2014.
- [5] I. Wikimedia Foundation, “Thermocouple.” <https://en.wikipedia.org/wiki/Thermocouple>, 2014.
- [6] A. Corporation, “Datasheet atmega128.” <http://www.atmel.com/devices/atmega128.aspx>, 2014.
- [7] M. Integrated, “Datasheet max31855.” <http://www.maximintegrated.com/en/products/analog/sensors-and-sensor-interface/MAX31855.html>, 2014.
- [8] M. Integrated, “Datasheet ds1337.” <http://www.maximintegrated.com/en/products/digital/real-time-clocks/DS1337.html>, 2014.
- [9] STMicroelectronics, “Datasheet lf33cv.” <http://www.st.com/web/en/resource/technical/document/datasheet/CD00000546.pdf>, 2014.
- [10] T. Instruments, “Datasheet lm2940ct-5.” <http://www.ti.com.cn/cn/lit/ds/symlink/lm2940-n.pdf>, 2013.
- [11] I. Wikimedia Foundation, “Raspberry pi.” [https://en.wikipedia.org/wiki/Raspberry\\_Pi](https://en.wikipedia.org/wiki/Raspberry_Pi), 2014.

# A

## Circuit diagrams

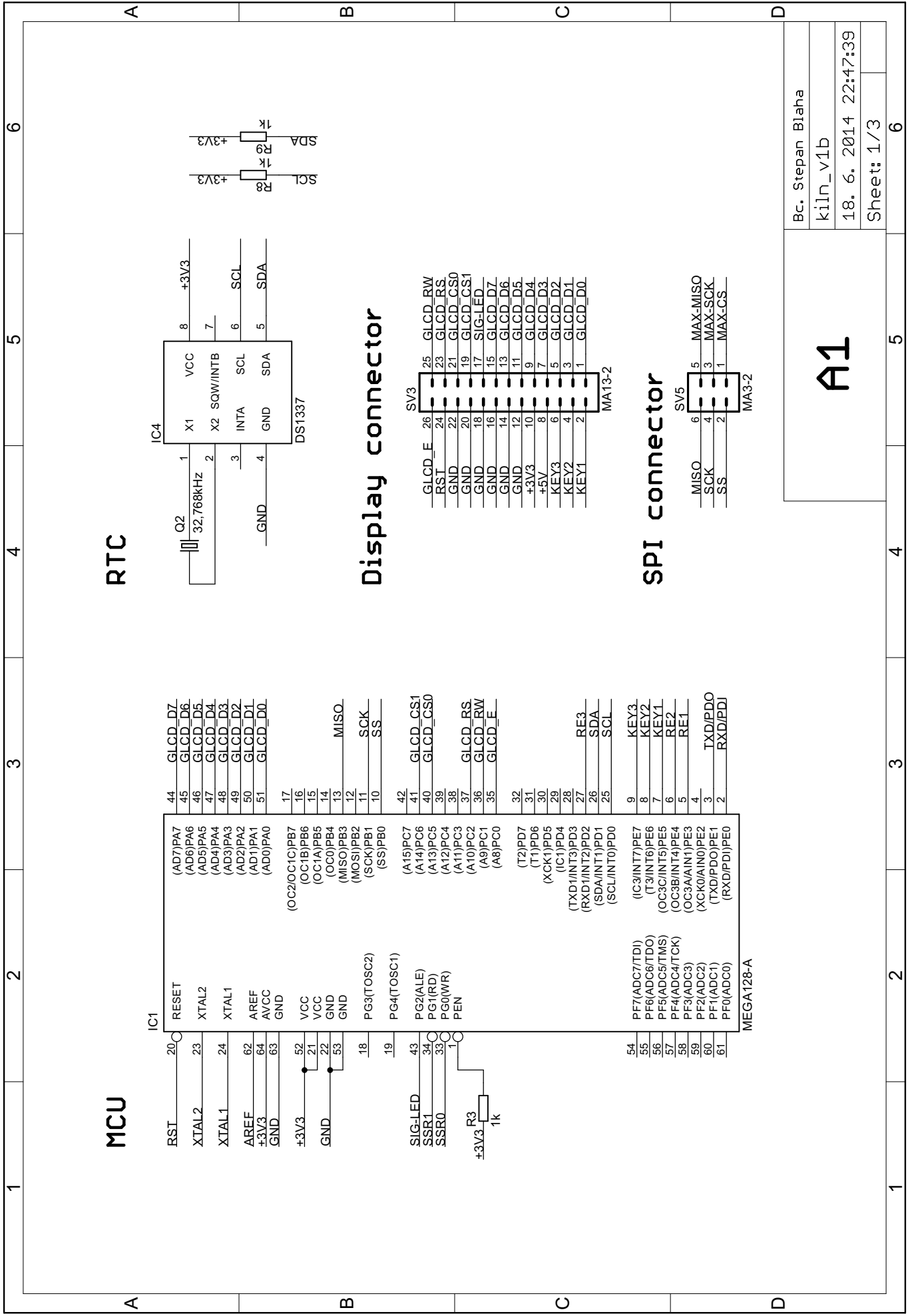
List of circuit diagrams:

A.1 Regulator

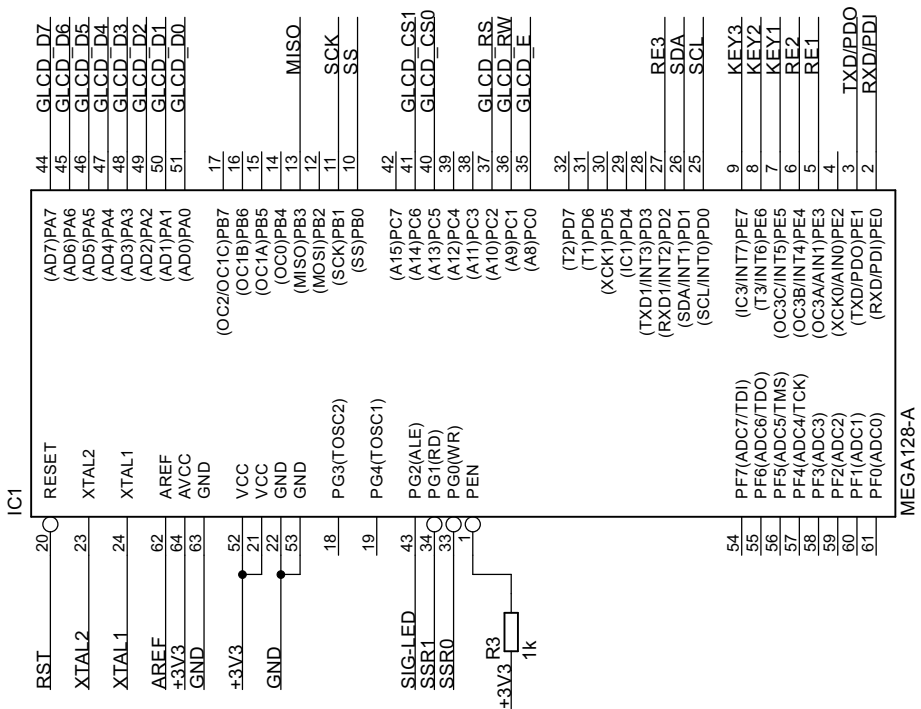
A.2 Power supply

A.3 Display and keyboard panel

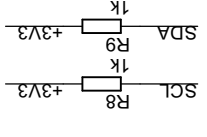
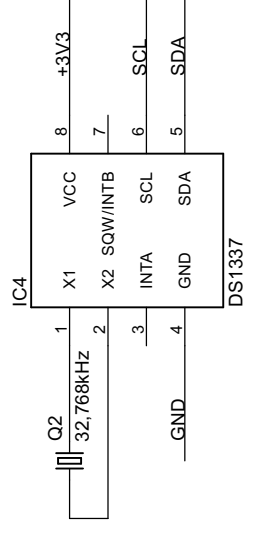
A.4 Rotary encoder



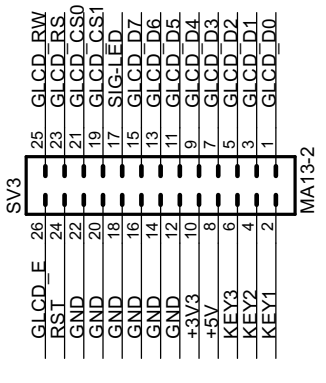
### MCU



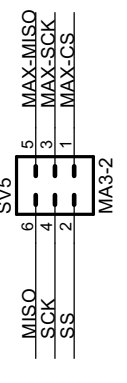
### RTC



### Display connector



### SPI connector



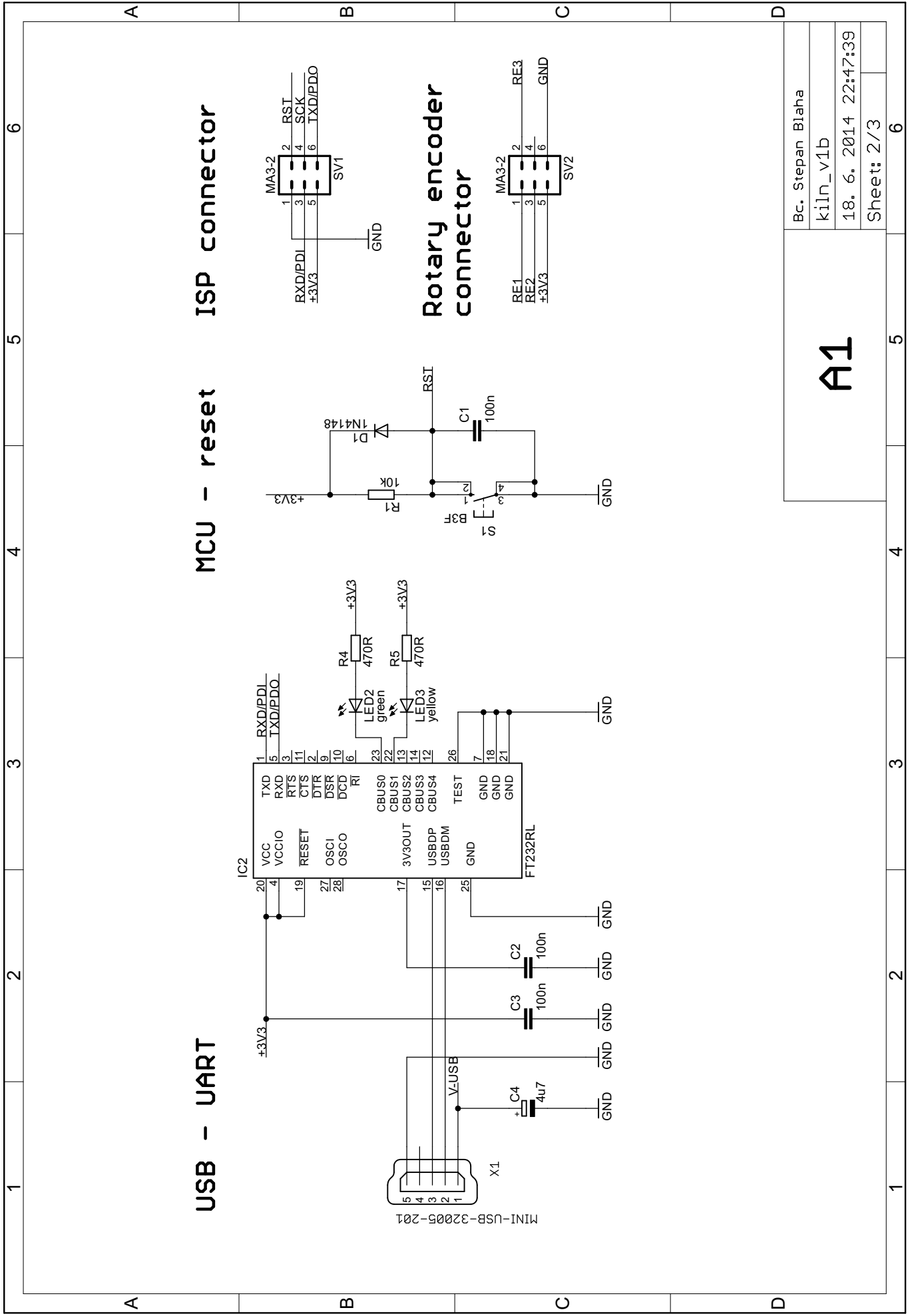
# A1

Bc. Stepan Blaha

kiin\_v1b

18. 6. 2014 22:47:39

Sheet: 1/3



**USB - UART**

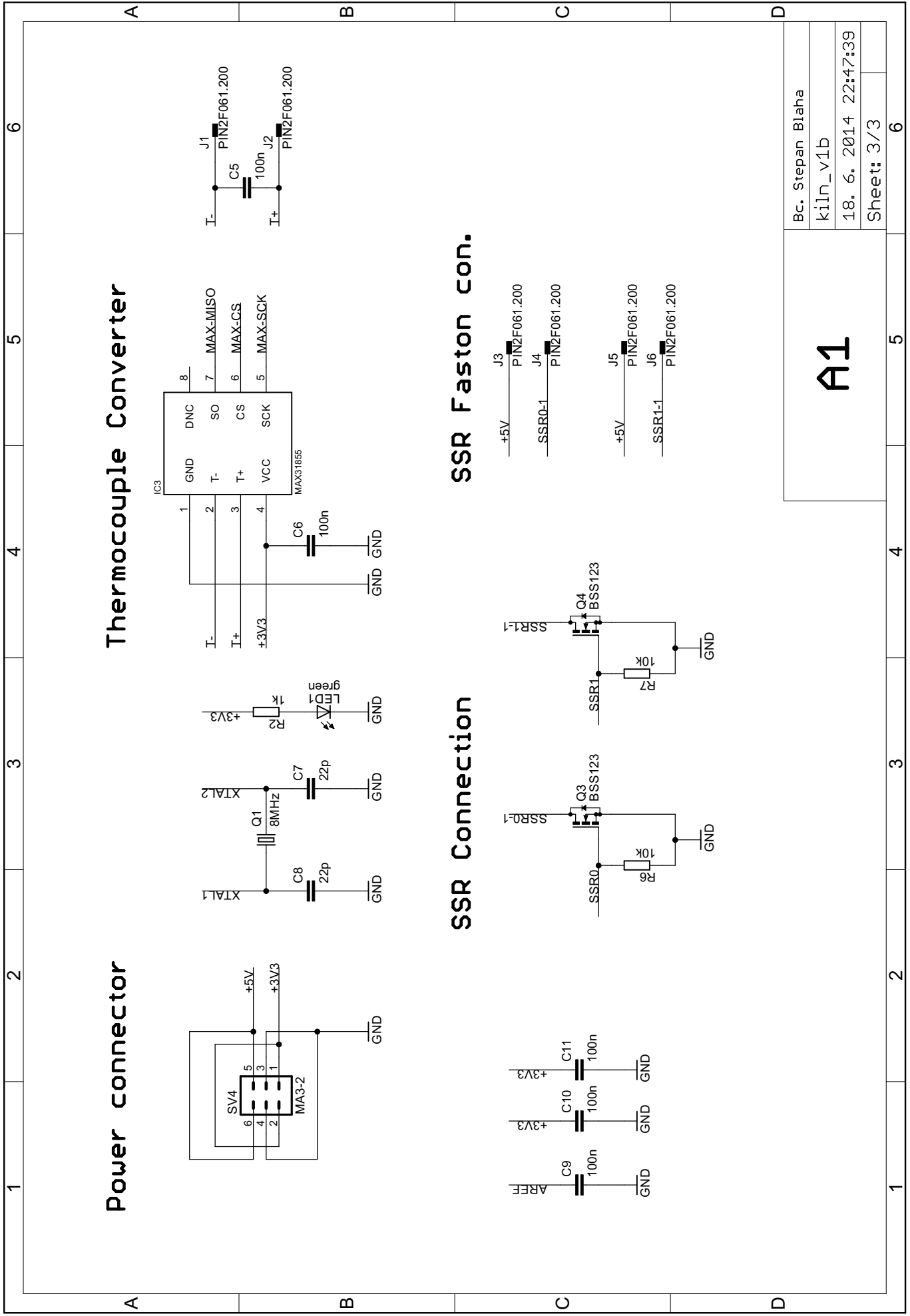
**MCU - reset**

**Rotary encoder connector**

Bc. Stepan Blaha	
kiln_v1b	
18. 6. 2014 22:47:39	
Sheet: 2/3	6

**A1**





### Power connector

### Thermocouple Converter

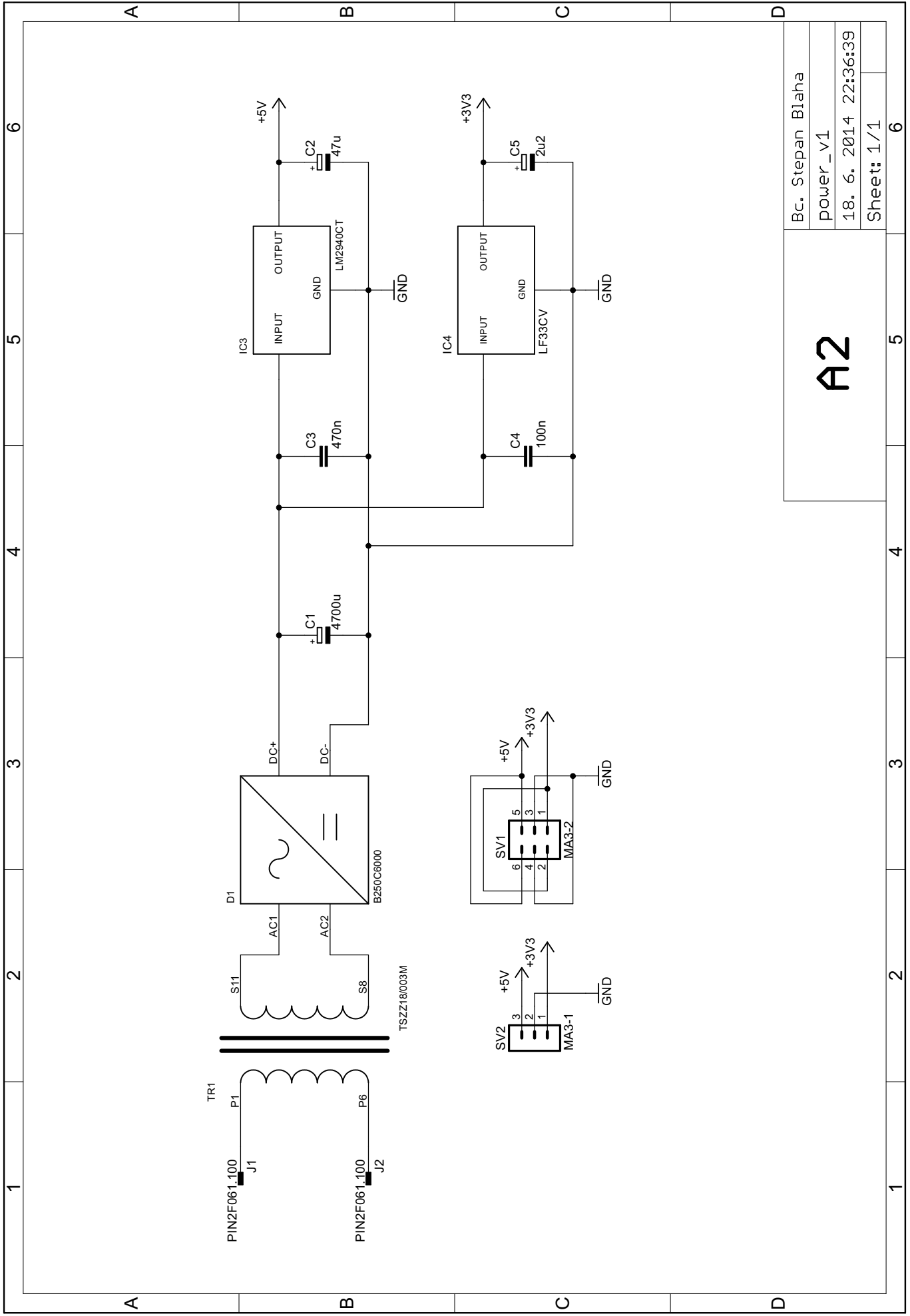
### SSR Connection

### SSR Faston con.

<b>A1</b>	
Bc. Stepan Blaha	
kiln_v1b	
18. 6. 2014 22:47:39	
Sheet: 3/3	

1 2 3 4 5 6

1 2 3 4 5 6



Bc. Stepan Blaha
power_v1
18. 6. 2014 22:36:39
Sheet: 1/1

A2

6

5

4

3

2

1

A

B

C

D

A

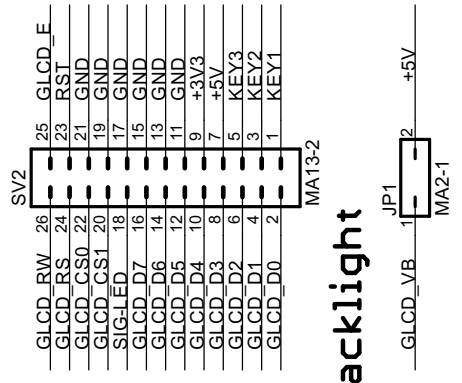
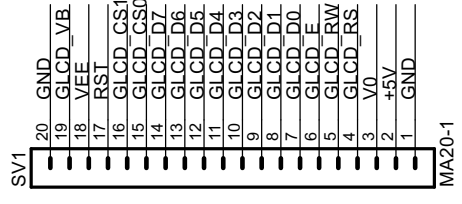
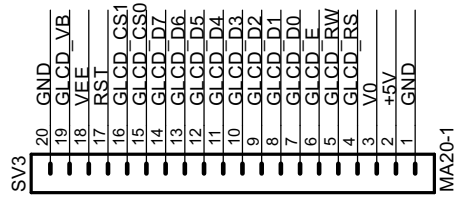
B

C

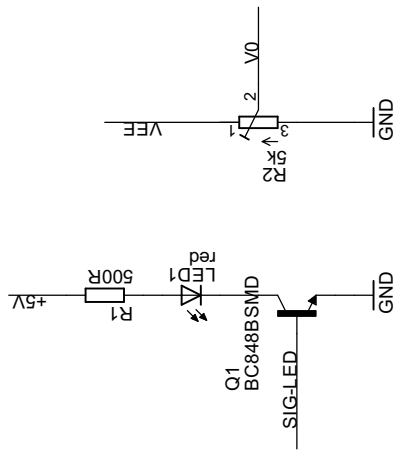
D

# Display connector 1

# Display connector 2



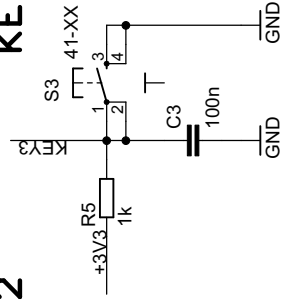
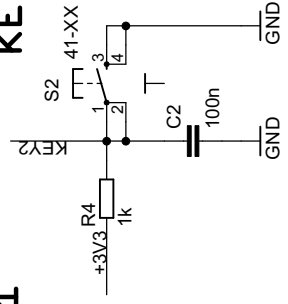
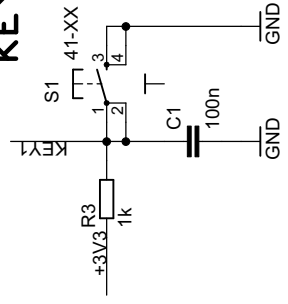
## Backlight



## KEY1

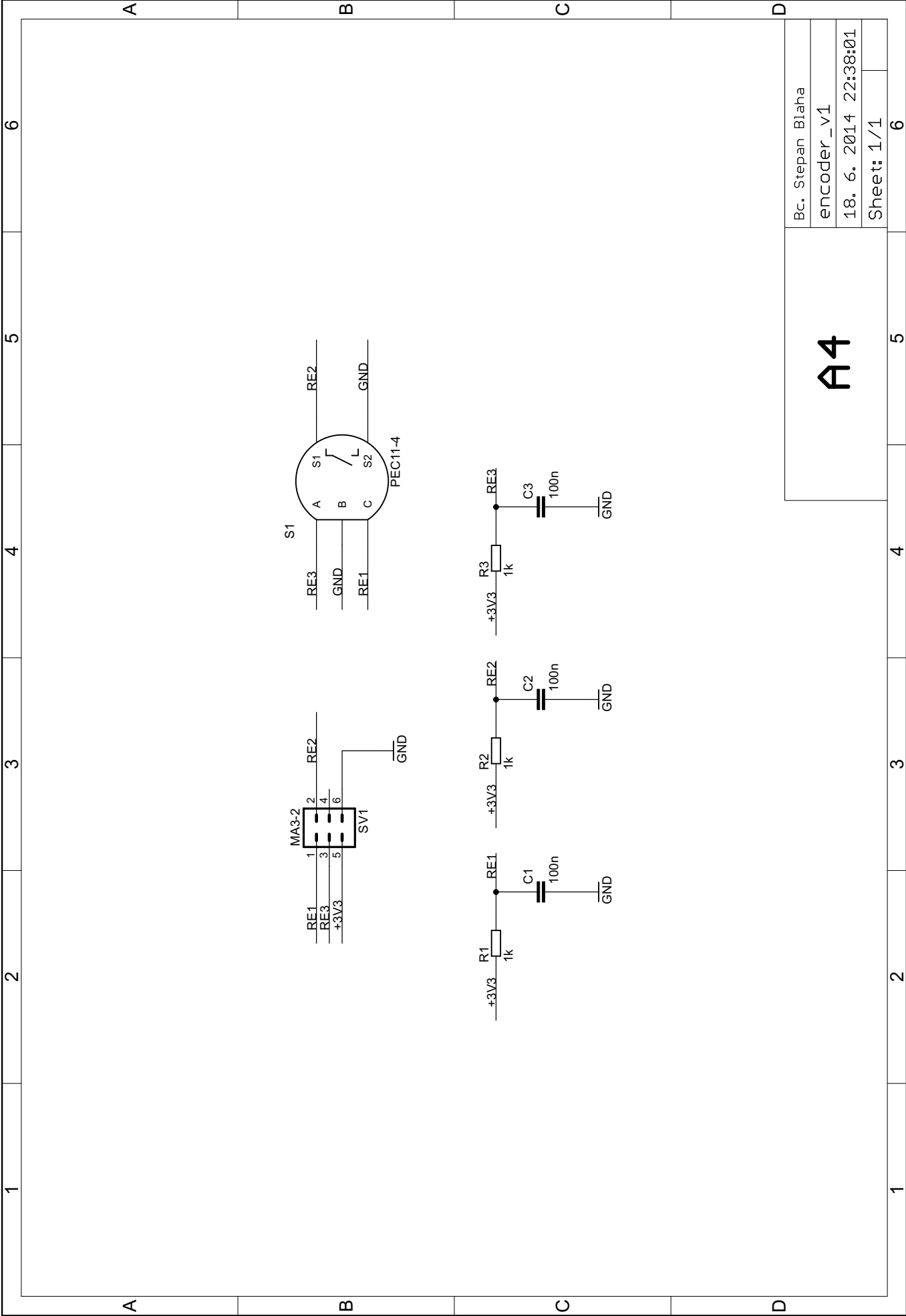
## KEY2

## KEY3



Bc. Stepan Blaha
panel_v1b
18. 6. 2014 22:26:45
Sheet: 1/1

A3

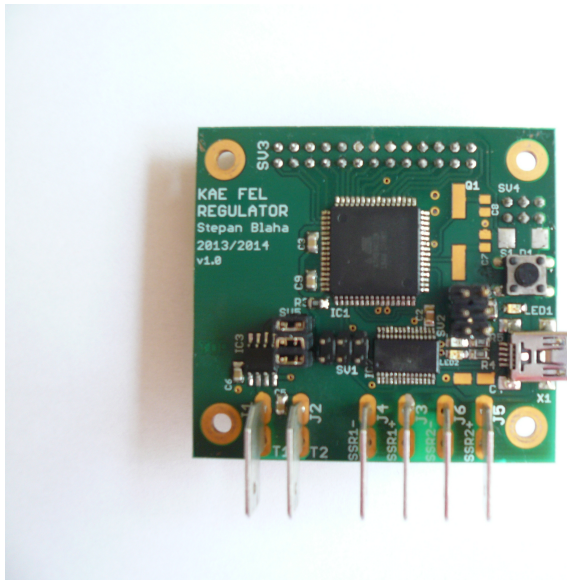


Bc. Stepan Blaha
encoder_v1
18. 6. 2014 22:38:01
Sheet: 1/1

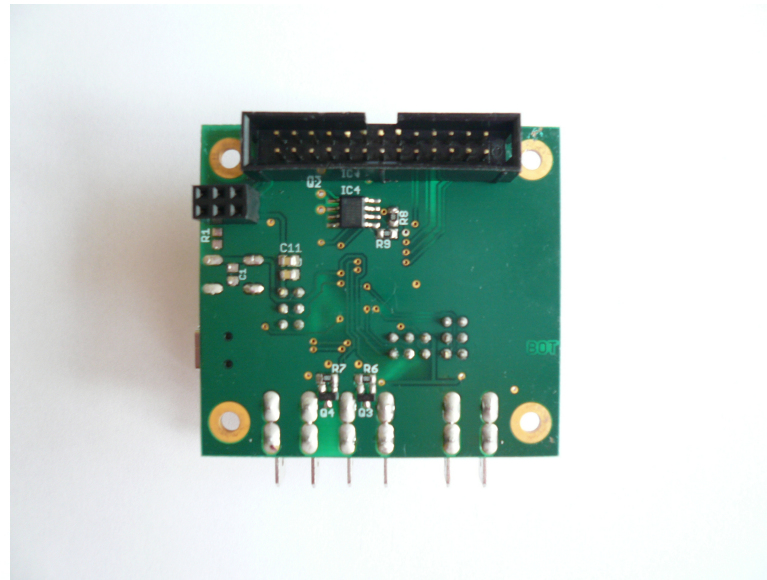
A4

# B

## Photos



(a) Regulator - top side

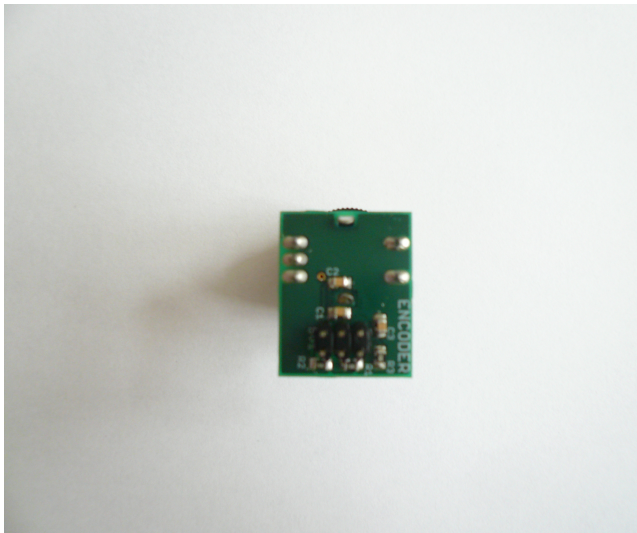


(b) Regulator - bottom side

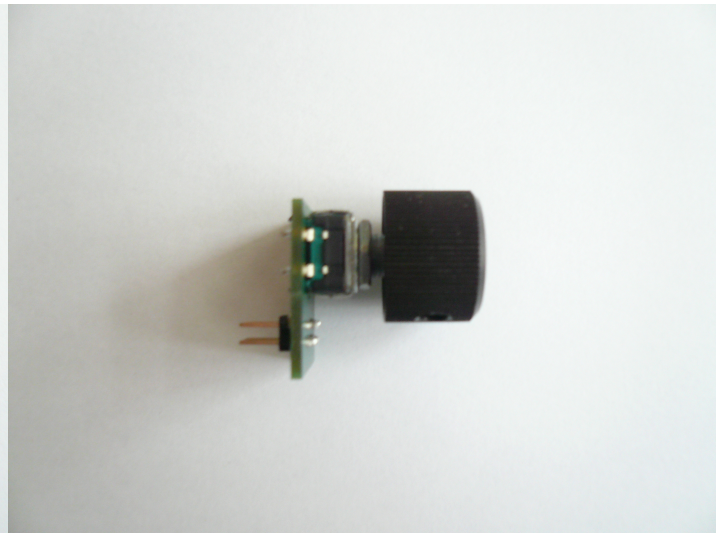
Figure B.1: PCB of Regulator



Figure B.2: PCB of Power supply



(a) Rotary Encoder - back side



(b) Rotary Encoder - left side

Figure B.3: PCB of Rotary Encoder

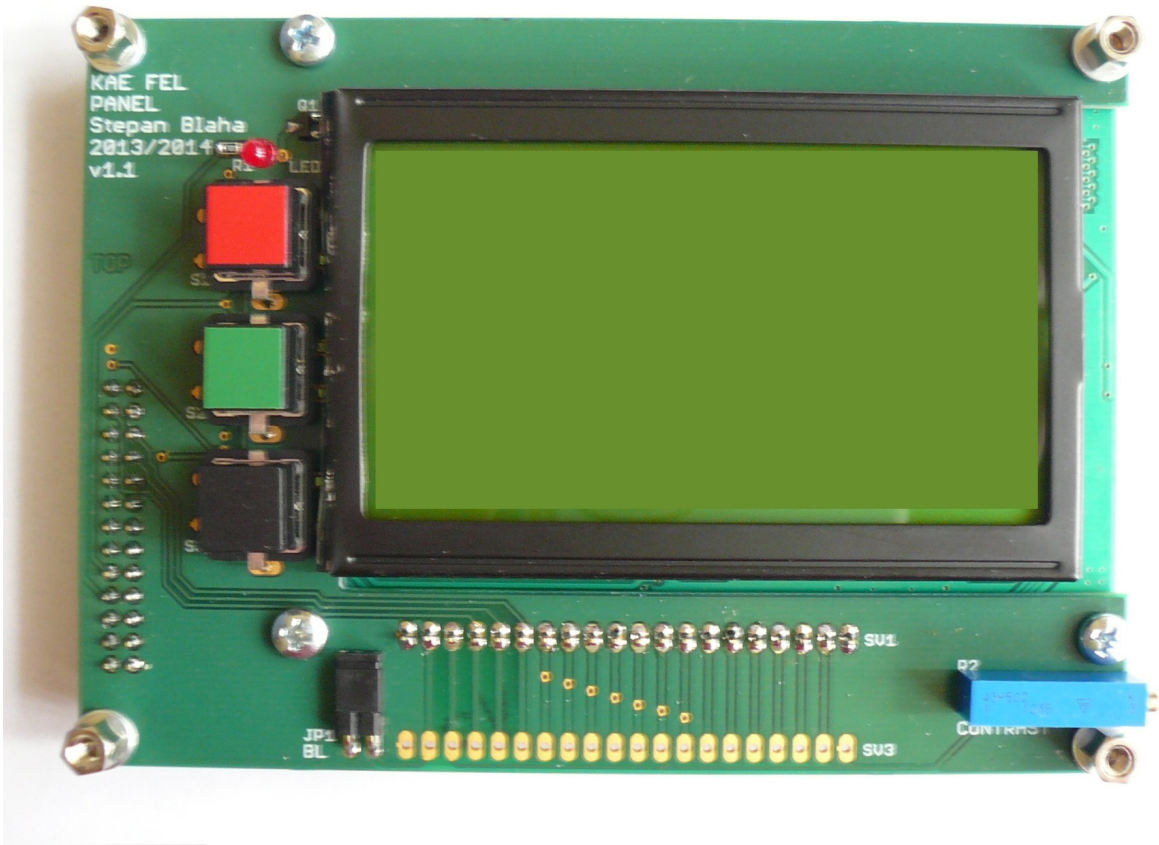


Figure B.4: PCB of Panel

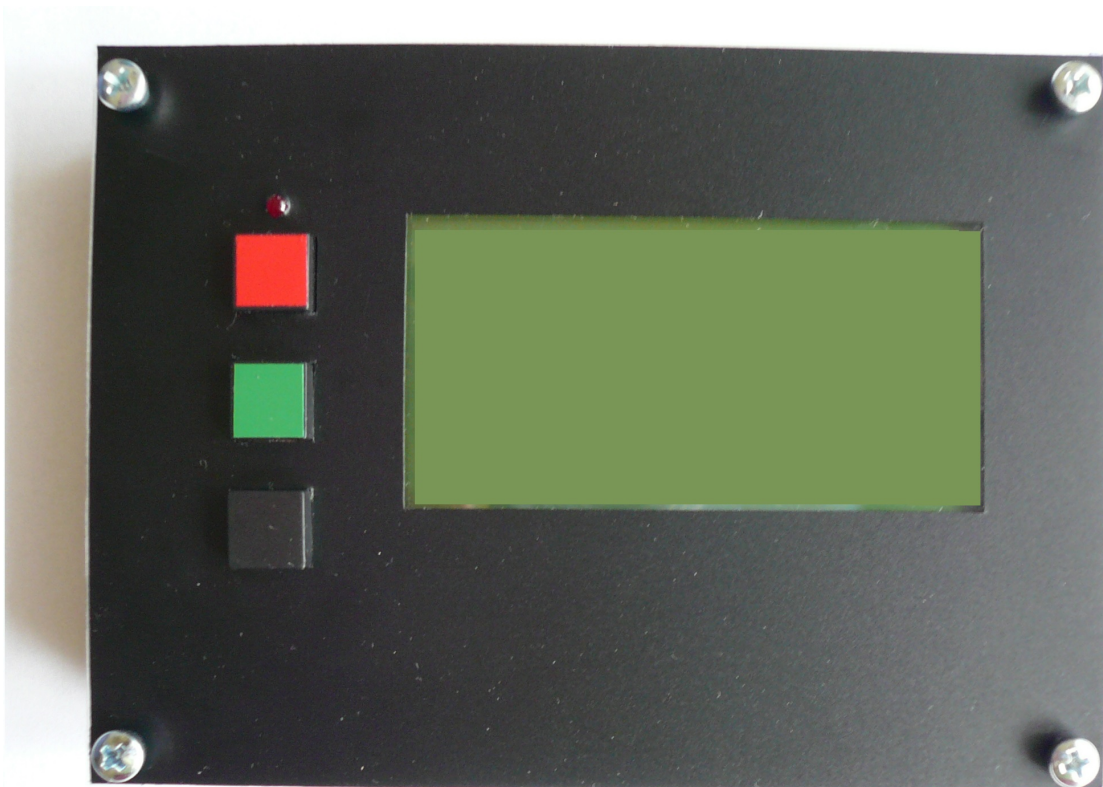


Figure B.5: PCB of Panel - 2