

The multi-axial material fatigue under the combined loading with mean stress in three dimensions

F. Fojtík^{a,*}, J. Fuxa^a

^aFaculty of Mechanical Engineering, VŠB – Technical University of Ostrava, 17 listopadu 15, 708 33 Ostrava-Poruba, Czech Republic

Received 20 August 2009; received in revised form 17 December 2009

Abstract

This contribution describes the application of Fuxa's conjugated strength criterion on the experimental results under combined loading of specimens made from common construction steel 11523.0, melt T31052. The specimens were stepwise loaded by the torque amplitude, combination of torque amplitude and tension pre-stress, further by the amplitude of the torque in combination with inner overpressure and axial tension force. The last set of specimens was loaded by the torque amplitude in combination with inner and external overpressure and with axial tension force. To obtain the data required as the input values for the conjugated criterion the stress/strain analysis of the specimens by the finite element method in software ANSYS was performed. The experiments were performed on modified testing machine equipped by overpressure chamber.

© 2009 University of West Bohemia. All rights reserved.

Keywords: high-cycle fatigue, experiment in multi-axial fatigue, mean stress effect, combined loading

1. Introduction

To verify the multi-axial Fuxa's conjugated strength criterion and to determine the proper constants the new test jig was developed which generalizes the possibilities of reconstructed testing machine SHENCK type PWXN [1, 2]. In this case the testing device was newly equipped by a multifunctional pressure chamber. This chamber makes possible to load the specimen by the inner/external overpressure in addition or independently in combination with torque amplitude. The constant tension/pressure pre-stress can be added into this system. The proper stress state combinations with the influence of mean stress can be realized in this way. Four types of experiments were performed which will be described in the following. The first two experiments serve to find the data required for the conjugated stress criterion. The third and fourth loading type overtakes this criterion setting and applies it on the experimental results.

2. Alternating torsion – experiment

The specimens were manufactured from the steel 11523.0, melt T31052. Their parameters are mentioned in Fig. 1. Those specimens were subsequently loaded by nominal amplitude of the torque with test frequency of 25 Hz. The amplitude of torque was gradually decreased until the limit 10^7 cycles was reached. The results experiment are placed in tab. 1. In the fig. 2 can be seen measured values, Fuxa's approximation curves (1) [5]. Point of crack initiation under static torsion was measured by reconstructed testing machine INOVA [3].

*Corresponding author. Tel.: +420 597 323 292, e-mail: frantisek.fojtik@vsb.cz.

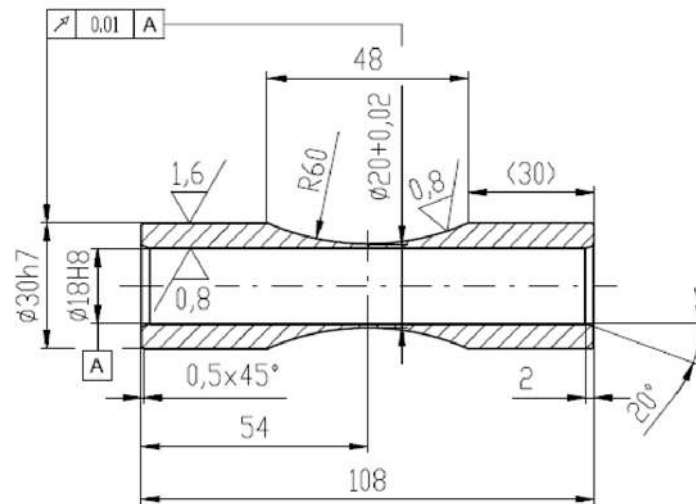

Fig. 1. Specimen

Table 1. Experimental results for alternating torsion

| Specimen Nr. | Stress amplitude τ_a [MPa] | Number of cycles | Notes |
|--------------|---------------------------------|------------------|--------------------|
| 1 | 214,4 | 30 800 | |
| 2 | 196,3 | 67 500 | |
| 3 | 178,2 | 683 620 | |
| 4 | 176,3 | 2 703 000 | |
| 5 | 172,2 | 10 810 000 | No crack generated |
| 6 | 516,6 | 0,25 | τ_f |

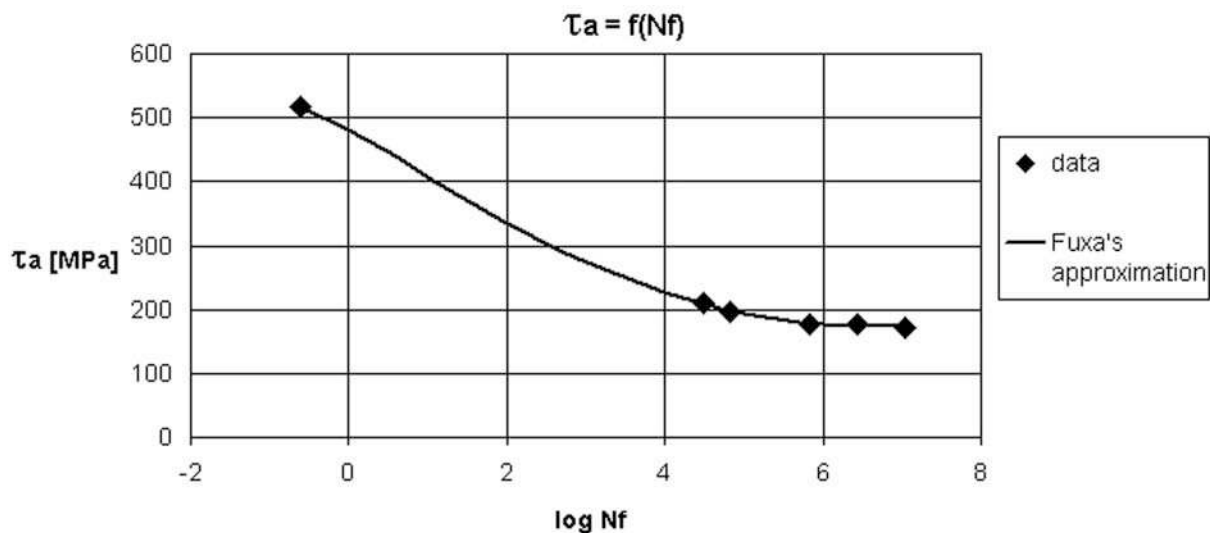

Fig. 2. S-N – curve for alternating torsion

Fuxa's approximation:

$$\tau_{aF} = (\tau_f + \tau_C) / 2 + [(\tau_f - \tau_C) / 2] \cdot \cos \{ \pi \cdot [\log(4 \cdot N_f) / \log(4 \cdot N_C)]^{a_1} \}, \quad (1)$$

for N_f in interval $[1/4; N_C]$ and τ_{aF} in interval $[\tau_f; \tau_C]$.

τ_f (516,6 MPa) is a value of real shear strength, τ_C (172,9 MPa) is the stress at the fatigue limit, N_C (6 400 000) is number of cycles at the fatigue limit, a_1 is constant, τ_{aF} is the limit stress amplitude under alternating torsion and N_f is the limit number of cycles until crack initiation. The mentioned values were obtained by nonlinear regression methods.

3. Alternating torsion – tension prestress – experiment

For this way of testing the same specimen as in previous case were used fig. 1. The specimens were loaded in every series by the constant tension pre-stress and consequently by nominal amplitude of the torque until the crack initiation. This amplitude was gradually decreased until the value when was the specimen able to endure 10^7 of cycles. The testing frequency was also 25 Hz.

The experimental results are shown in the tab. 2 and figured in fig. 3. The results are here approximated by Fuxa’s approximation (2, 3, 4, 5) which takes the influence of the mean stress into the account. Particular approximations are based on measured number of cycles which is mentioned in fig. 3.

Table 2. Experimental results for alternating torsion and tension prestress

| Specimen Nr. | Tension Stress σ_t [MPa] | Stress amplitude τ_a [MPa] | Number of Cycles | CH_F [%] | Notes |
|--------------|---------------------------------|---------------------------------|------------------|------------|--------------------|
| 1 | 266,1 | 154 | 401 000 | 3,82 | |
| 2 | 266,1 | 145,5 | 637 600 | 1,42 | |
| 3 | 266,1 | 136,6 | 10 487 000 | 2,42 | No crack generated |
| 4 | 191,6 | 178,5 | 110 300 | 1,69 | |
| 5 | 191,6 | 162,3 | 310 500 | 3,06 | |
| 6 | 191,6 | 146,5 | 11 300 000 | 2,34 | No crack generated |

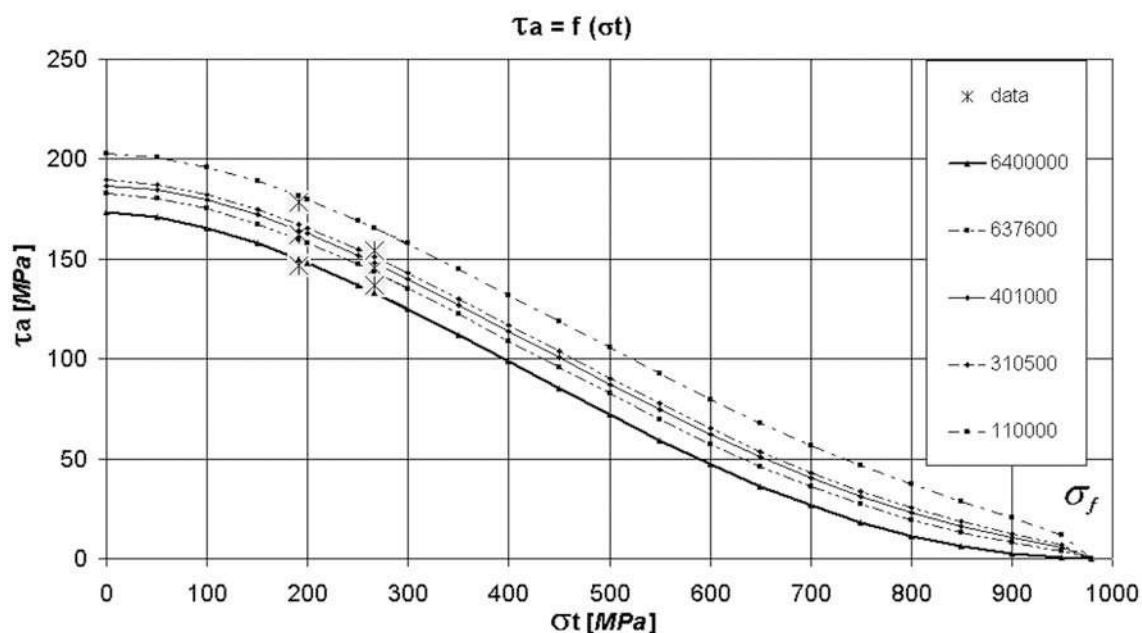

Fig. 3. Fuxa’s approximation for combined torsion – tension loading

Fuxa’s approximation with influence of mean stress:

$$\tau_{aF2} = (\tau_f^* + \tau_C^*) / 2 + [(\tau_f^* - \tau_C^*) / 2] \cdot \cos \{ \pi \cdot [\log(4 \cdot N_f) / \log(4 \cdot N_C)]^{a_1} \}, \quad (2)$$

$$\tau_f^* = 1/\sqrt{3} \cdot \left((\sqrt{3} \cdot \tau_f)^2 - 2 \cdot \sqrt{3} \cdot \tau_f \cdot B_O \cdot \sigma_t / 3 + \sigma_t^2 \cdot B_O^2 / 9 - \sigma_t^2 \right)^{1/2}, \quad (3)$$

where (4) is the static strength condition for $N_f = 1/4$ and constant B_O is equal to:

$$B_O = 3 \cdot \left(\sqrt{3} \cdot \tau_f / \sigma_f - 1 \right), \quad (4)$$

$$\tau_C^* = \tau_C / 2 \cdot \left\{ 1 + \cos \left[\pi \cdot (\sigma_t / \sigma_f)^B \right] \right\} \text{ is the strength condition for } N_f = N_C. \quad (5)$$

σ_f (979,2 MPa) is the real tension strength value, τ_f is a value of real shear strength, τ_C is the stress at the fatigue limit, N_C is number of cycles at the fatigue limit, a_1 and B are constants, τ_{aF2} is the limit amplitude of shear stress, σ_t is the constant tension stress and N_f marks the limit number of cycles until crack initiation. The absolute mean relative error value of used approximation is mentioned in tab. 2 and can be determined according to following formula:

$$CH_F = ABS(\tau_{ai} - \tau_{aFi}) / \tau_{ai} \cdot 100 \%, \quad (6)$$

τ_{ai} are the measured stress amplitude values and τ_{aFi} are the values calculated according to the Fuxa’s approximation (2).

4. Alternating torsion – inner overpressure and tension prestress – experiment

For this way of testing the same specimen as in previous case were used fig. 1. Every series of specimens was loaded by different constant overpressure. The torque amplitudes were chosen for every series. Specimens were loaded by that amplitude until the crack initiation. This amplitude was gradually decreased until the value when was the specimen able to endure 10^7 of cycles. The testing frequency was also 25 Hz. The results of those experiments are mentioned in tab. 3.

Table 3. Experimental results for alternating torsion and a inner overpressure

| Nr. | Overpressure [MPa] | Tension mean Stress $\sigma_t = \sigma_a + \sigma_{t1}$ [MPa] | Stress amplitude τ_a [MPa] | Number of cycles | CH_F [%] | Notes |
|-----|--------------------|---|---------------------------------|------------------|------------|--------------------|
| 1 | 10 | 151,8 | 176,2 | 256 500 | 0,38 | |
| 2 | 10 | 151,8 | 162,3 | 1 475 600 | 0,68 | |
| 3 | 10 | 151,8 | 155,3 | 10 080 000 | 1,41 | No crack generated |
| 4 | 15 | 219 | 166,7 | 441 500 | 5,39 | |
| 5 | 15 | 219 | 160,1 | 1 234 000 | 6,92 | |
| 6 | 15 | 219 | 146,7 | 11 058 000 | 1,74 | No crack generated |
| 7 | 20 | 303,7 | 149,6 | 175 000 | 0,02 | |
| 8 | 20 | 303,7 | 134,6 | 2 374 000 | 6,72 | |
| 9 | 20 | 303,7 | 124,4 | 10 750 000 | 0,33 | No crack generated |

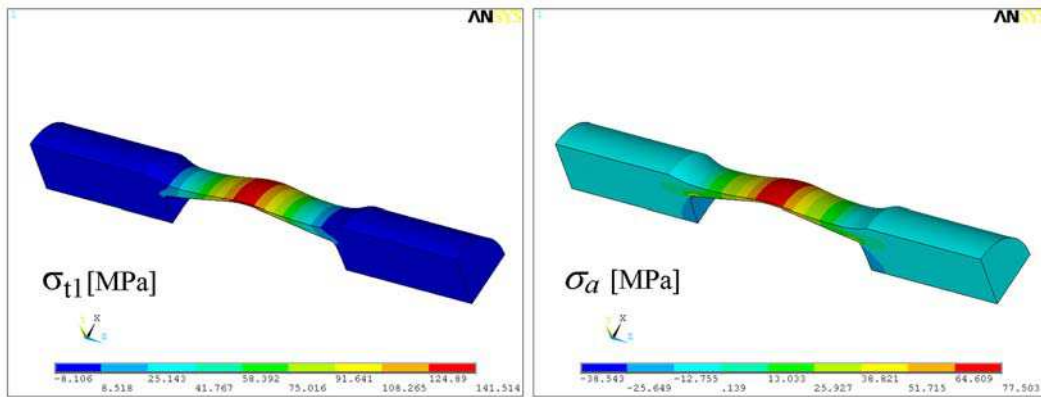

Fig. 4. Circumferential and axial stresses for inner overpressure 15 MPa

On the base of stress state evaluation of the specimen the significant circumferential σ_{t1} and axial σ_a stress can be observed on the surface. Hence this stress state had to be determined by finite element method in software ANSYS [6].

The static analysis was performed, where 1/4 of specimen. The material parameter was obtained on the base of tensile test. The boundary conditions are chosen so that the resting 3/4 of specimen is compensated by symmetry and further one point of specimen face is fixed in three directions (x, y, z). Opposite end of the specimen is free. On the relevant length the inner overpressure was applied thereby the axial force is put into the specimen. Results for given overpressure are in tab. 3. The calculated circumferential and axial stress (MPa) for the pressure of 15 MPa figured in fig. 4.

Results obtained from performed experiments and computation are on fig. 5. Those results are approximated Fuxa's approximation (2, 3, 4, 5) which takes into account the influence of mean stress. It is necessary to adjust equation (3) according to the strength criterion formulation [4] for obtained stress state.

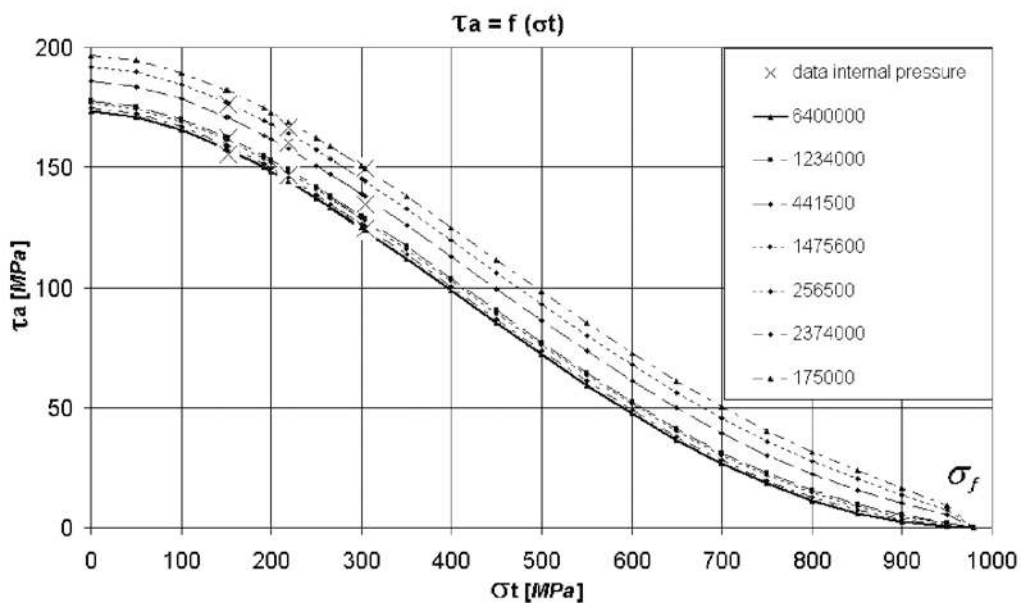

Fig. 5. Fuxa's approximation for combined torsion – inner overpressure loading

Particular approximations result from measured number of cycles written in tab. 3. The constant determined in previous experiment are used in this case. The curves at the fatigue limit are in the case of both described problems equivalent. The absolute value of mean relative error CH_F (6) is mentioned in tab. 3 as well.

5. Alternating torsion – inner and external overpressure and tension prestress – experiment

For this way of loading was the testing machine SHENCK type PWXN [1] equipped by a new type of specimen fixation which makes possible to use the overpressure chamber. This chamber is connected with multiplier and with hydraulic aggregate which serves for gaining of inner and external overpressure in the range 0–70 MPa. For this way of testing the same specimen as in previous case were used.

The tests were performed so that the first series of specimens was loaded simultaneously by inner and external overpressure of 40 MPa. For this inner/external overpressure the torque amplitude was chosen by which the specimen was loaded until the crack initiation. This amplitude was subsequently reduced until the value when the specimen was able to endure 10^7 of cycles. Those experimental results are in tab. 4.

Table 4. The experimental results for alternating torsion with the influence of mean stress from inner/external overpressure and tension loading

| Nr. | Pressure [MPa] | Tension force [N] | Tension mean Stress $\sigma_t = \sigma_a + \sigma_{t1} + \sigma_R$ [MPa] | Stress amplitude τ_a [MPa] | Number of cycles | CH_F [%] | Notes |
|-----|----------------|-------------------|--|---------------------------------|------------------|------------|--------------------|
| 1 | 40 | 0 | 172,4 | 178 | 197 860 | 0,79 | |
| 2 | 40 | 0 | 172,7 | 169,1 | 1 261 800 | 6,38 | |
| 3 | 40 | 0 | 172,3 | 157,2 | 11 160 000 | 2,21 | No crack generated |
| 4 | 40 | 7 000 | 35,7 | 184 | 97 500 | 10,78 | |
| 5 | 40 | 7 000 | 35,7 | 174,8 | 1 022 500 | 1,69 | |
| 6 | 40 | 7 000 | 35,7 | 167,2 | 10 470 000 | 2,85 | No crack generated |

The second series of specimens was loaded by inner and external overpressure of 40 MPa simultaneously by axial tension force. The torque amplitude by which the specimen was loaded until the crack initiation was determined for this loading case as first. In case of following specimens this amplitude was subsequently reduced until the value when the specimen was able to endure 10^7 of cycles. Due to such complicated loading the mean stress in three dimensions was established in the specimen.

From the stress state analysis follows that in case of specimen loaded in described way the significant circumferential σ_{t1} , axial σ_a and radial σ_R stress appear. Those stresses can not be analytically determined in the simple way due the complicated shape of the specimen and faces where the inner and external overpressure is applied. Base on this fact the described stress state was determined by the finite element method in software ANSYS.

The static analysis was performed in both cases. The model was pen as 1/4 of the specimen which was meshed by the SOLID186 element. The material parameters were obtained from the tension test. The boundary conditions were chosen so that the remaining 3/4 of the specimen is substituted by the symmetry and further the displacement is constrained in three directions (x, y, z) on one face. The other end of the specimen is free. The inner and external overpressure

was applied on the appropriate faces of the specimen. Those faces are based on the dimensions and sealing of the specimen. The simulation results for both series and given loading type are in tab. 4. The results of circumferential, axial and radial stresses (MPa) obtained from performed analysis by FEM for inner and outer overpressure of 40 MPa are in fig. 6.

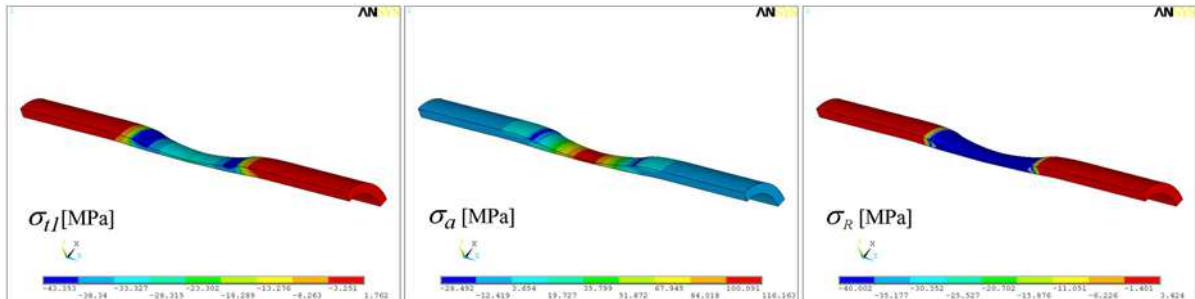

Fig. 6. Circumferential, axial and radial stresses for inner and external overpressure 40 MPa in specimen – Nr. 2. in tab. 4

The both experimental and simulation results are in fig. 7. Those results are approximated by described Fuxa’s approximation (3, 4, 5, 6) which takes the influence of the three-dimensional mean stress into the account. It is necessary to adjust equation (4) into the shape which takes the influence of three-dimensional mean stress into the account for obtained stress state.

The particular approximations are based on the measured cycles number from tab. 4. The approximation on the fatigue limit is same as in the case of previous experiments. The same constants of used approximation are used here as well. In fig. 7 the good agreement between the obtained experimental results and proposed approximation can be seen.

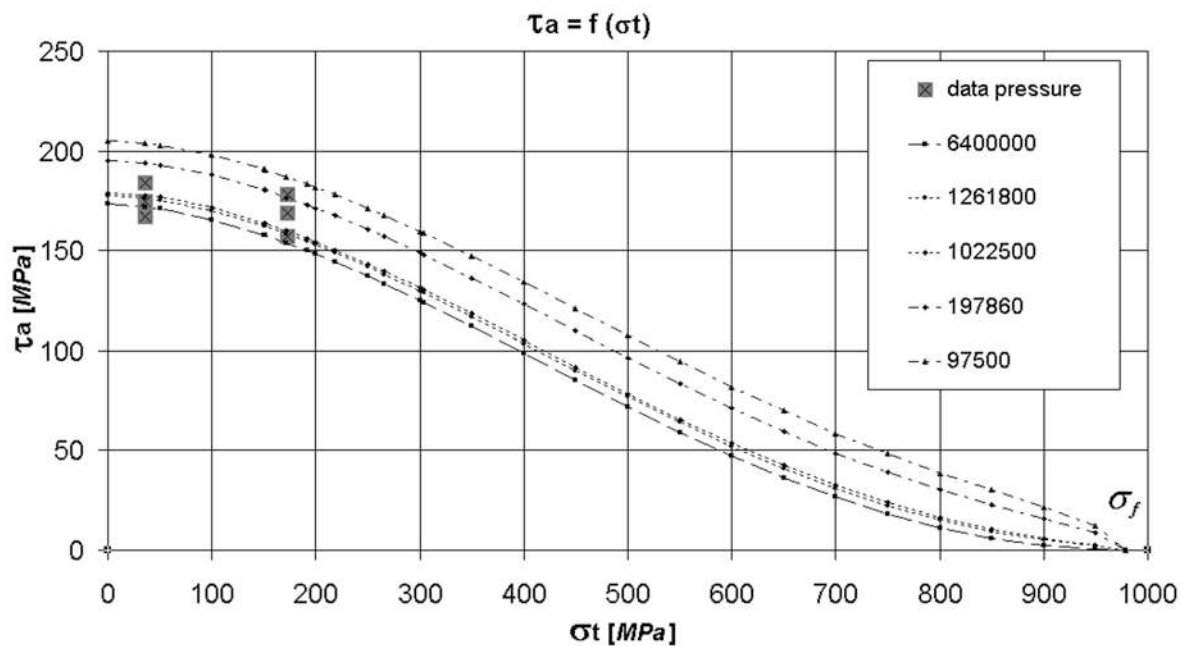

Fig. 7. The Fuxa’s approximation for combined loading by torsion – inner, external overpressure and axial force

6. Conclusion

The four types of experiments on the specimens made from the steel 11523.0, melt T31052 are subsequently mentioned in this contribution.

First experiment – alternating torsion. Obtained results are approximated Fuxa's approximation. The Fuxa's approximation embodies a good agreement with experiment – see fig. 2.

Second experiment – combined loading by alternating amplitude of torque and by constant axial tension force. Also here the Fuxa's approximation embodies the good agreement with experiment – see fig. 3. The constants of strength criterion were tuned on this experiment.

The third experiment – combined loading by the amplitude of the torque with the influence of mean stress which is created by the inner overpressure and axial tension force here. The relevant hoop and axial stresses are obtained by the static stress/strain analysis by FEM. The experimental results are approximated by Fuxa's approximation whose constants result from previous experiment. The good agreement can be seen here and hence it is possible to state the appropriate constant tuning for further possible combined loading – see fig. 5. The maximum absolute mean relative error value of used approximation is here 6,92 %. Described approximation is a part of conjugated stress criterion, see [4] for more details.

The fourth experiment – combined loading by the amplitude of the torque with the influence of mean stress which is created by the inner and external overpressure and axial tension force here. The relevant circumferential, axial and radial stresses are obtained by the static stress/strain analysis by FEM in software ANSYS. The experimental results are approximated by the Fuxa's approximation of the Conjugated strength criterion. The good agreement with the experimental results in the area the fatigue limit can be seen here.

Acknowledgements

The paper was created under support of GACR, project no: 101/08/P141.

References

- [1] Fojtík, F., The Experimental Machine for the Multiaxis Fatigue Testing of Material, Dissertation Thesis, FS VŠB-TU Ostrava, 2007.
- [2] Fojtík, F., The Fatigue Testing Machine and Experiment, In: Applied Mechanics 2008, Wisla, Polsko, 2008.
- [3] Fuxa, J., Fojtík, F., Kubala, R., Torque machine fit for high cycle fatigue of material testing, In: Experimental Stress Analysis 2007, Hotel Výhledy, 2007.
- [4] Fuxa, J., Kubala, R., Fojtík, F., Idea of Conjugated Strength, In: Experimental Stress Analysis 2006, Červený Kláštor, Slovensko, 2006, pp. 125–130.
- [5] Fuxa, J., Kubala, R., Fojtík, F., Poruba, Z., Reconstruction of the Torque Test Machine and Its Utilization for Strength Criterion Searching In: Experimental Stress Analysis 2005, Skalský dvůr, 2005.
- [6] Fojtík, F., Fuxa, J., Examination of the Fatigue Life under Combined Loading of Specimens, Applied and Computational Mechanics, Volume 2, Number 1, 2008, pp. 37–44, ISSN 1802-680X.