

Numerical Simulation of the Detection of Crack in Reinforced Concrete Structures of NPP Due to Expansion of Reinforcing Corrosive Products Using Impact-Echo Method

Š. Morávka^{a,*}

^aNew Technology Centre in Westbohemian Region, University of West Bohemia in Pilsen, Univerzitní 8, 306 14 Plzeň, Czech Republic

Received 10 September 2008; received in revised form 23 October 2008

Abstract

Nuclear energy boom is starting nowadays. But also current nuclear power plants (NPP) are duty to certify their security for regular renewal of their operating licenses. NPP security can be significantly affected by defects of large amount of ageing reinforced concrete structures. Advanced Impact-Echo method seems to be very hopeful to cooperate at performing in-service inspections such structures. Just these in-service inspections are included in the first priority group of specific technical issues according to the recommendations of OECD-Nuclear Energy Agency, Commission on Safety of Nuclear Installation in the field of ageing management.

This paper continues of extensive project dealing with Impact-Echo method application. It will present a method description and main results of numerical modeling of detection and localization of crack caused by corrosive product expansion. Steel reinforcing rods are subjected to corrosion due to diffusion of corrosive agents from structure surface. Corrosive products have up to 7-times larger volume than pure steel. Raised strain can lead up to concrete failure and crack development. We investigate whether it is possible to detect these growing cracks by Impact-Echo method in time.

Experimental verification of our numerical predictions is prepared on Civil Faculty in Brno.

© 2008 University of West Bohemia in Pilsen. All rights reserved.

Keywords: concrete structures, reinforcing, Impact-Echo, diagnostics, wave propagation, numerical simulation, crack, void, corrosion

1. Introduction

In-service inspections of NPP reinforced concrete structures having thick section and with not directly accessible areas are included in the first priority group of specific technical issues according to the recommendations of OECD-Nuclear Energy Agency, Commission on Safety of Nuclear Installation in the field of ageing management. The method, how to do it more reliably, quickly and cheaply as well are still looked for. Just advanced Impact-Echo method seems to be hopeful.

This method, according to ASTM C 1383-98a, [1], consists in the locating of void's position by the elastic wave reflections between the void or inhomogeneities and surface. Generally, it is possible to use the method in two ways. The matter of technique in the first approach (in frequency domain, exactly according to the referenced ASTM) consists in the fact that the frequency of wave reflections between the void and surface (or between two surfaces) depends on the depth of the void. Knowing the wave propagation velocity and by using the discrete

*Corresponding author. Tel.: +420 377 634 708, e-mail: moravka@ntc.zcu.cz.

fast Fourier transform we can in real time identify the dominant frequency and hence compute void's depth (or thickness of the wall).

In the second application way (in time domain) the voids can be localized directly by the transient wave reflections from the discontinuities and inhomogeneities, according the amplitude, shape and time arrival of reflected waves. This technique is not so common, but it can give next useful results, see e.g. [3] or [32]. It is very difficult, even impossible, e.g. to detect surface crack and/or to set its depth and inclination in the frequency domain. We, unlike the most authors, e.g. Dr. Schubert's group in Fraunhofer Institute, Dresden [30, 31], generally focus on usage of Impact-Echo method in the time domain mode, see all our references next. But in suitable cases, where the defect has one face (or, at least a part of its surface) parallel to the wall surface, where we identify multiple wave reflections between void and wall surface, we confirmed detection in frequency domain as well. The comparison and good agreement of both approaches was shown in [18, 19, 20].

In preceding works were tested the capabilities of Impact-Echo for the detection and localization of reinforcing rods [13, 25] and numerical simulations of detection of perpendicular cracks on the both surfaces — accessible as well as inaccessible [14, 25]. Next, the depth effects of cracks perpendicular to the surface were tested in [15, 26, 27]. The localization of the closed crack inside the wall was modeled as well, see [15, 26, 27]. Many simulation and discussion were done about the oblique cracks detection and trying set its inclination angle and depth [16, 28, 29]. Localization and setting orientation of the large cavities in different positions were simulated in [18, 19]. Finally was simulated detection of cavities repaired by grouting polyurethan compound Carbopur WF, to try to confirm if cavities were fulfilled properly, [21, 22].

This paper deals with the numerical detection and localization of cracks caused by expansion of steel rust. Corrosive agents diffuse through the concrete cover layer to the reinforcing (rods, lattice). Here electrochemical corrosive reaction happens. The water presence as electrolyte is needed as well. Rust products have up to seven time larger volume, than original reinforcing steel. It leads at first to the tensile radial strain in reinforcing rods surroundings. The strain can leads to the failure of concrete — first near the rods only, but with continued corrosion process cracks can grow. Rapid aggravation starts when the cracks achieve the open surface. Then corrosive processes accelerate. In the lattice reinforcing case growing cracks can join each other. It leads to the delamination of whole covering layer.

On the contrary, from the mechanical design point of view the covering concrete layer is wanted to be minimized. That's why the corrosion generally remains as serious problem of all reinforced concrete structures.

So, it is very important to find out the starting phase of cracks growing. We try to confirm whether it is possible to detect such failures at their starting phase by the Impact-Echo method.

We collaborate with two workplaces from the Faculty of Civil Engineering, University of Technology in Brno on this problem. Colleagues on the Institute of Building Testing are finishing verification experiments. The main problem here appears the technique of internal pressure introduction. Some possibilities are considered — pressure hosepipe with oil inserted into the drilled holes or some mixture of chemical expansive masses. Technical difficulties must be solved in both these cases.

On the numerical part we closely cooperate with another workplace of faculty — Institute of Structural Mechanics. Here our colleagues D. Matesová and M. Vořechovský are interested in the analytical and numerical solution of crack development. They present the comparison of analytical models proposed by Liu and Weyers and Li et al. with numerical method in paper [7].

They use nonlinear finite elements code ATHENA, see [6]. A material constitutive model based on a smeared approach is applied to accept concrete nonlinear behavior. Smeared approach can successfully describe crack propagation. Partly fracture-plastic model named NLCEM is used. Concrete with reinforcement is modeled as a 2D problem. Expansion of corrosion products is introduced by application of negative shrinkage of the steel reinforcement elements. At first, the deterministic model was tested. But uniform distribution of crack round the bar is not very realistic. So, the stochastic model was employed in next. Real concrete has not quite uniform properties in its volume. The spatial variability of material is introduced into model by random fields of concrete parameters. It disturbs rotational symmetry and introduces damage initialization more similar to real life.

The models with reinforcing geometry corresponding to the design of NPP containment were ordered for the numerical simulations of the Impact-Echo method. Two numerical models of crack growing were realized in Brno by using code ATHENA described above. First experiment consists of single reinforcing rod, second simulates reinforcing lattice by three parallel rods. Crack developing at step-by-step rust expansion was simulated as 2D model. We can see the result at latter phase of crack growing on fig. 1a) (single rod) and fig. 1b) (three rods). These “cracks maps” were exploited as input in our subsequent 3D models.

2. Numerical Models

Numerical models of Impact-Echo diagnostics are realized by finite element method. We simulate fast transient processes of elastic wave propagation in the cuts of the concrete wall sized 0.5 by 0.5 by 0.1 meters (one rod) and 0.9 by 0.5 by 0.1 meters (lattice), see fig. 2a) and 2b). The measures of 0.1 m are expanded by using semi-infinite elements to represent 1 m thick walls in NPP. Real specimens with such reinforcing are in cooperating experimental laboratory in NRI Řež and specimens with complete geometry exactly designed by numerical models are finished on the Institute of Building Testing. Using planar symmetry we can solve half-reduced models consisting of approx. 105,000 or 180,000 3D finite elements of size 5 by 5 by 5 mm.

The single point excitations are step by step applied on the specimen's surface at the straight line going through the specimen's center. This 0.5 or 0.9 meters line consists of 51 or 91 excitation points shifted by 1 cm step (every other node); see fig. 2a), b). The responses — i.e. time histories of displacement perpendicular to surface - are for every case taken (i.e. for every excitation) from all of 101 or 181 nodes located on the same line where excitation is applied step-by-step.

There were computed two sets of responses, every counting 51 and 91 extensive computations for separate positions of excitation as described above. The first set responds to the reinforced specimens without any flaw, second set corresponds to the specimens with crack at stage depicted on figs. 1a), b).

2.1. Software

For the numerical simulation of Impact-Echo diagnostic method a finite element method implemented in commercial software MARC/MENTAT from MSC Corporation was employed. This software was more times used formerly, see referenced citations Morávka, Pečínka and Voldřich, 2003–2007 and was tested and verified in comparison with real experiments and analytical solutions as well, e.g. in [8, 9, 11, 12].

The final computations we realized in parallel, on META Centre academic network. 14 processors have been used for every task (because we can use 28 MARC licenses).

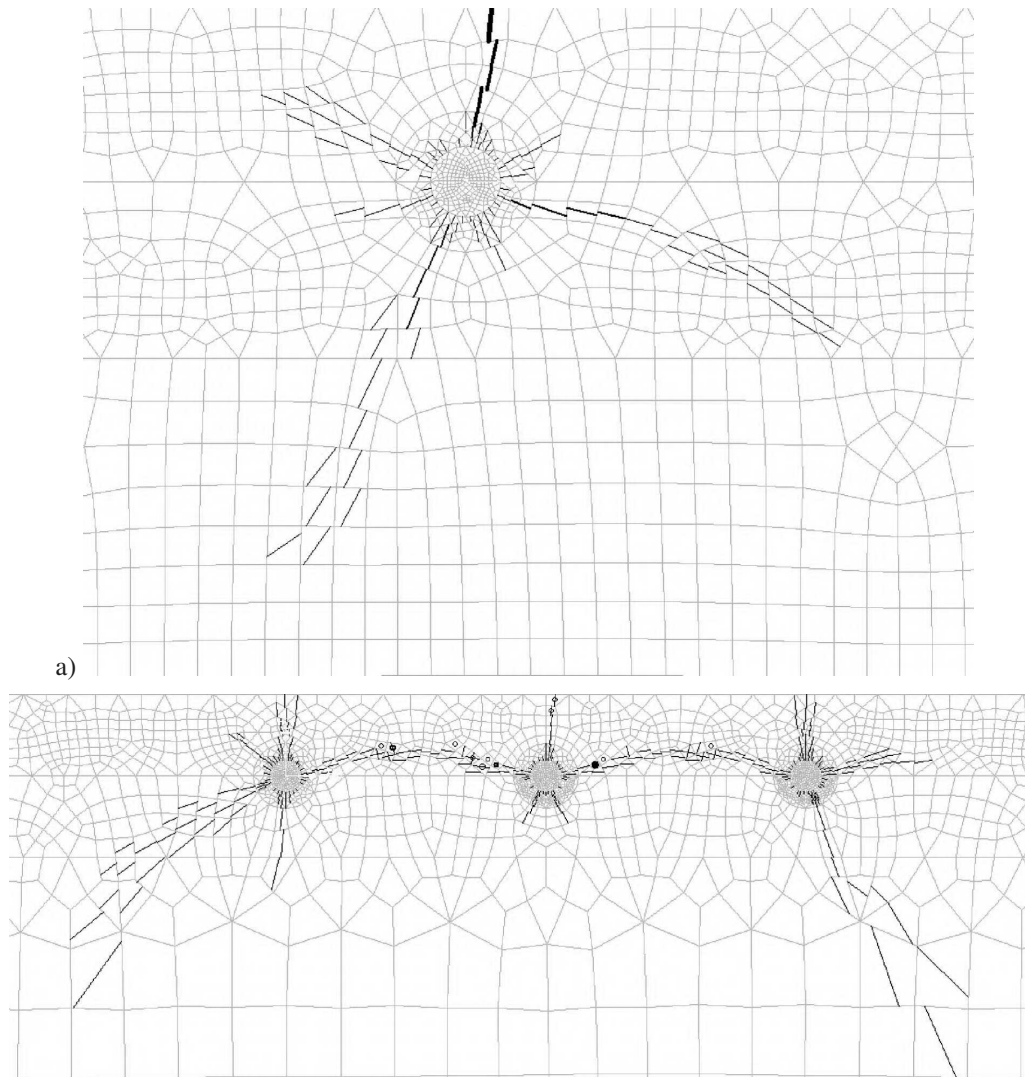

Fig. 1. a) 2D model of cracks distribution by ATHENA program in specimen with one rebar, b) 2D model of cracks distribution at latter phase by ATHENA program in specimen with lattice reinforcing. Both figures according to Matesová and Vořechovský

2.2. Spatial and time discretizations

Both the reinforced concrete specimens are 3D bodies modeled by 8-nodes isoparametric elements with full integration. The discretization must be finer here to be able to correctly describe relatively small reinforcing rods and some cracks. Hence the element's edges have been chosen sized 5 mm only. It leads to the huge models exceeding the computation possibilities. Therefore the massive part of pure concrete inside of the walls was replaced by semi-infinite elements. These elements can be used to model unbounded media in one direction. In this semi-infinite direction, the interpolation functions are exponential, such that the displacement function is zero at the far domain.

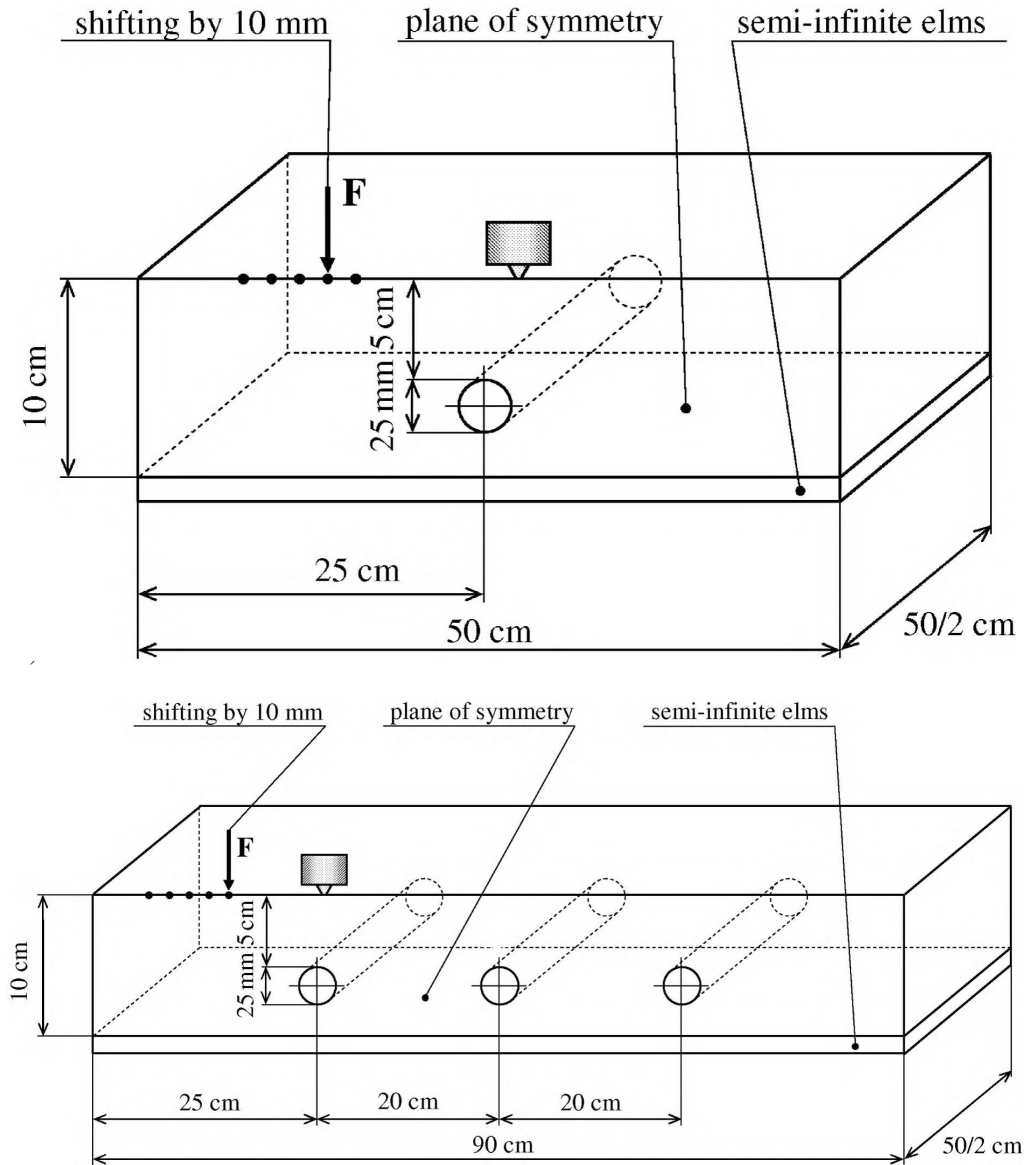

Fig. 2. a) Scheme of the model with single reinforcing rod. Cracks are not depicted here, b) Scheme of the model with lattice type reinforcing. Cracks are not depicted here

The element size determines the shortest wave being able to propagate in such model without numerical amplitude attenuation. The shortest wavelength is $\lambda_{\min} = 10$ mm. It responds to so called cut-off-frequency at, approximately, 410 kHz. Frequency band of numerical simulation is in the same way restricted by time integration step size as well. Therefore, it is suitable to choose spatial and time discretizations such “fine”, that the both frequency limitations will be “similar”. Moreover, we could not use elements of varying size for this type of problems (it results different cut-off-frequencies and wave dispersions, spurious wave reflections, etc.).

These all facts mentioned above lead to very extensive and time consuming computations. For more details see e.g. [24, 4, 5, 10].

Time integration step with regard to the element size was chosen $\Delta t = 1.2 \mu s$. Time integration consists of 200 steps and it is executed up to time $t = 240 \mu s$, from where the results starts to be degraded by the wave reflections from the lateral and rear specimen's borders.

2.3. Integration method

The Newmark integration method has been employed for time discretization. The Newmark coefficients were been slightly modified from their basic version, to $\beta = 0.275625$ and $\gamma = 0.55$. By this way the moderated numerical dumping was introduced. It suppresses spurious higher frequencies namely, but still keeping unconditioned method stability.

The opinions on usage suitability of explicit or implicit formula for transient processes are different. One step of computation by explicit method (like central difference) consumes less computation time, but to reach the same accuracy the shorter time step is needed. Moreover, it is suitable to choose the time integration method with regards to the spatial discretization type. The spatial discretization with full (consistent) mass matrix used here and time discretization by Newmark method leads to partial elimination of spurious effects of the both discretizations each other, see e.g. [10].

2.4. Materials

Concrete mixture according to the technical report about concreting at the NPP Dukovany (see [2]) consists of sand with 4 mm grains and aggregates up to 16 mm sized. It is possible to consider concrete to be approximately *homogeneous*, because the shortest wavelength $\lambda_{\min} = 10$ mm being able to propagate in model is similar. Next, the concrete is made by casting, so it can be considered as *isotropic*. And finally, test loadings are very small, so it will be sufficiently enough to use the *elastic* model. Mechanical properties respond to the concrete B30 (NPP Dukovany) according to that time standard ČSN 73 12 01.

Steel parameters correspond to the common building steel. A small layer of rust between rods and concrete was neglected.

2.5. Excitation

It has been proposed to simulate an impact of experimental hammer. According to impactor size and velocity we estimate impact at force 5 000 N taking time 36 μs . Hitherto realized tests indicate, that considerably weaker impact will be enough for real experiments.

3. The Results of Numerical Simulations

First illustrative results see on fig. 3a) and b). The displacement distribution in time 60 μs are depicted on both of these figures. Fig. 3 a) is the model with single reinforcing rod, fig. 3b) shows the model with 3 rods representing the part of reinforcing lattice. On the both figures we can observe, how the cracks grown up to surface rapidly prevent surface Rayleigh wave propagation namely. These crack developments are in their later stage. We can see that splitting of cover layer has occurred already on the specimen with lattice, figure 3 b). Splitting is dominant wave barrier of dilatation and shear wave propagation and therefore it can be detected by Impact-Echo quite reliably.

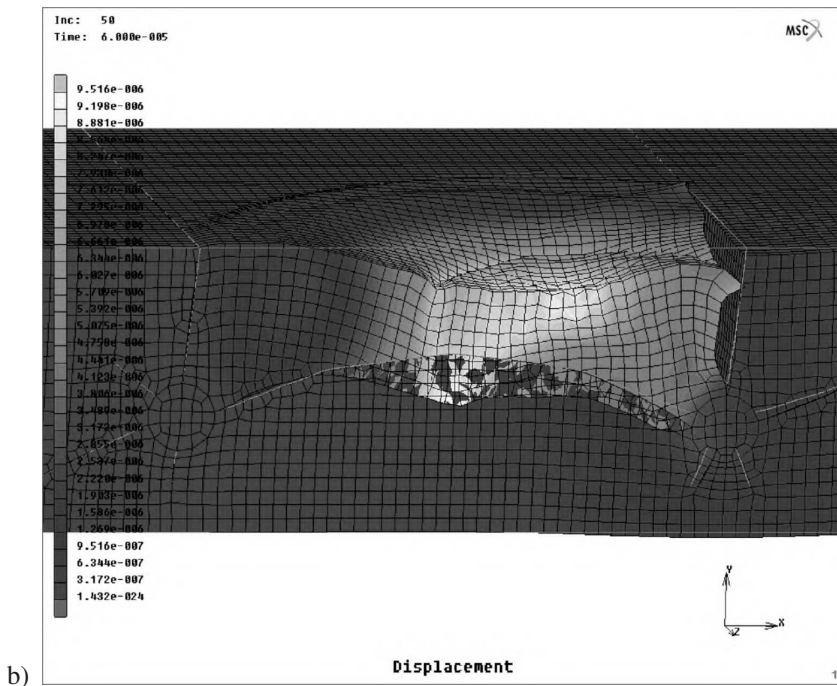
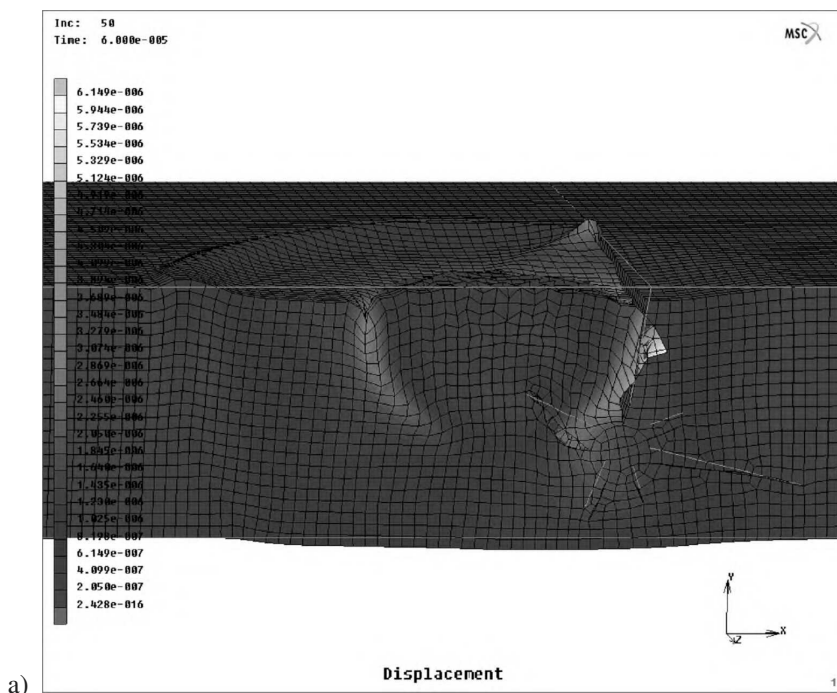

Fig. 3. a) Displacement distribution at time $60 \mu s$ for the part of model with single reinforcing rod, b) Displacement distribution at time $60 \mu s$ for the part of model with lattice type reinforcing

Following two graphs, figs. 4a) and b), represent comparisons of time histories taken from points, where the greatest reflection from rod can be expected (like a ray reflection). Figure a) belongs to the specimen with single rod and fig. b) to the specimen with lattice type reinforcing. In both cases, the thin lines are time histories taken from specimens with rod(s) without any cracks and thick lines correspond to the concrete damaged by crack development.

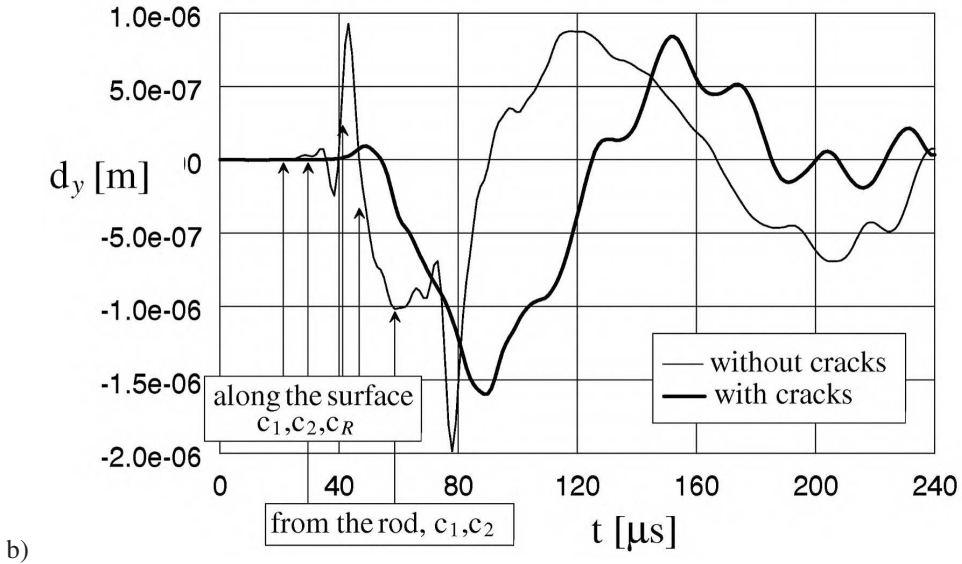
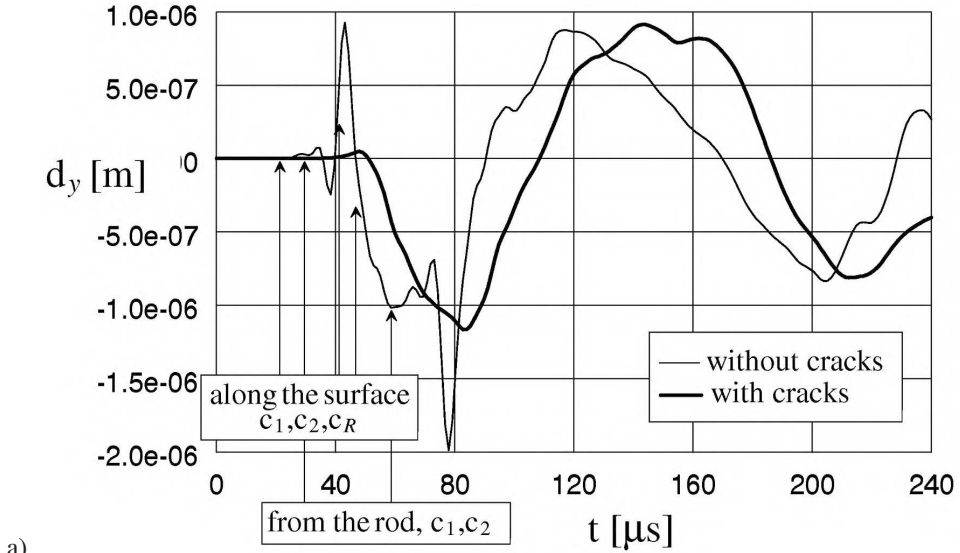

Fig. 4. a) Comparison of time histories of displacements for the specimens with and without the crack. One rod reinforcing, b) Comparison of time histories of displacements for the specimens with and without the crack. Lattice type reinforcing

We can utilize here all opinions obtained by simulation of previous simpler flaws (see references Morávka, Pečínka). At first we can see how the crack coming up to surface rapidly prevents Rayleigh wave propagation. Two sharp peaks on thin lines are Rayleigh wavefronts (corresponding to the start and end of excitation force action). These peaks are filtered on the thick lines. We know already, that Rayleigh wave also will develop, but in farther distance. Second utilized opinion is a fact that the shear wave reflection brings first substantial information about the rod presence. It can be observed around the time $34.7 \mu\text{s}$. The presence of split layer is indicated by the bigger difference of lines at fig. 4b) than fig. 4a).

Very interesting is shape of the thick line from time approx. $100 \mu\text{s}$ later. On the Figure 4b) namely it is possible to recognize a regular periodic component at period approx. $25 \mu\text{s}$, what corresponds to the frequency $f = 40 \text{ kHz}$. If we employ the formula from ASTM describing Impact-Echo method (see reference [1]) $H = \frac{c_1}{2f}$, where c_1 is known speed of dilatation wave in concrete, we obtain depth of flaw $H = 0.05 \text{ m}$. It is a confirmation the frequency approach of Impact-Echo diagnostic, because it is exactly depth of delamination caused by join of crack growing from lattice rods.

Following figs. 5a) and b) display all time history responses on excitation at distance 0.2 m ; fig. a) the single rod and b) for the lattice type specimen. The cracks are present in both situations. Excitation is located nearby the middle rod. Single response in distance 0.3 m was displayed on figs. 4a) and b) already by thick lines. Here we can observe in both figures, that the curves from figs. 4 are located behind the crack (in direction from the excitation). This crack at distance 0.26 m in case of single rod or 0.457 m in case of three rods can be clearly recognized. It disturbs the outstanding Rayleigh wave face and shifts it (with reduced amplitude) to the later time (see earlier opinion as well). Regular reflections corresponding to the cover layer splitting are recognizable in fig. 5b) as well. Outstanding wave peaks near the excitation points are caused by excitation action focused into a single point — they are not important here.

4. Conclusions and next activities

Generally, it can be very hardly estimated, how the cracks can be located. Some wave reflections can be multiple, e.g. among two cracks, or reinforcing rods and surface. Situation can be made more clearly from the B-scan of some larger part of specimen's surface, e.g. see [18, 19]. A comparison of Impact-Echo responses of defectless structure with state after some exploitation time will be definitely useful as well.

As mentioned, these numerical Impact-Echo predictions will be verified by experiments on real specimens (1 : 1). Colleagues from Institute of Building Testing in Brno intend to realize a set of experiments with different stage of cracks development. If they succeed, the Impact-Echo diagnostic will be probed on their specimen before specimen's cutting. Then analytical and numerical predictions of Matesová and Vořechovský [7] mentioned above will be confronted with cuts.

The experimental measurements on real specimens in NRI Řež (scaled 1 : 1) by various diagnostic methods are parts of the project as well. There were (or will be) realized measuring by ultrasound (Inset Liberec and Civil Faculty TU Brno), optically by Moire method (Institute of Thermomechanics Prague), optically by pulse ESPI method (Music Faculty, Academy of Performing Arts Prague), radiography (Civil Faculty of TU Brno) and by Impact-Echo (using licensed B&K sensor and originally designed transducer and exciter as well).

Within the frame of whole project the techniques of automated Impact-Echo excitation, and response scanning are developed, including own devices design. The prototypes of automated scalable impactor and piezoceramic transducers are made and under testing in NRI Řež now.

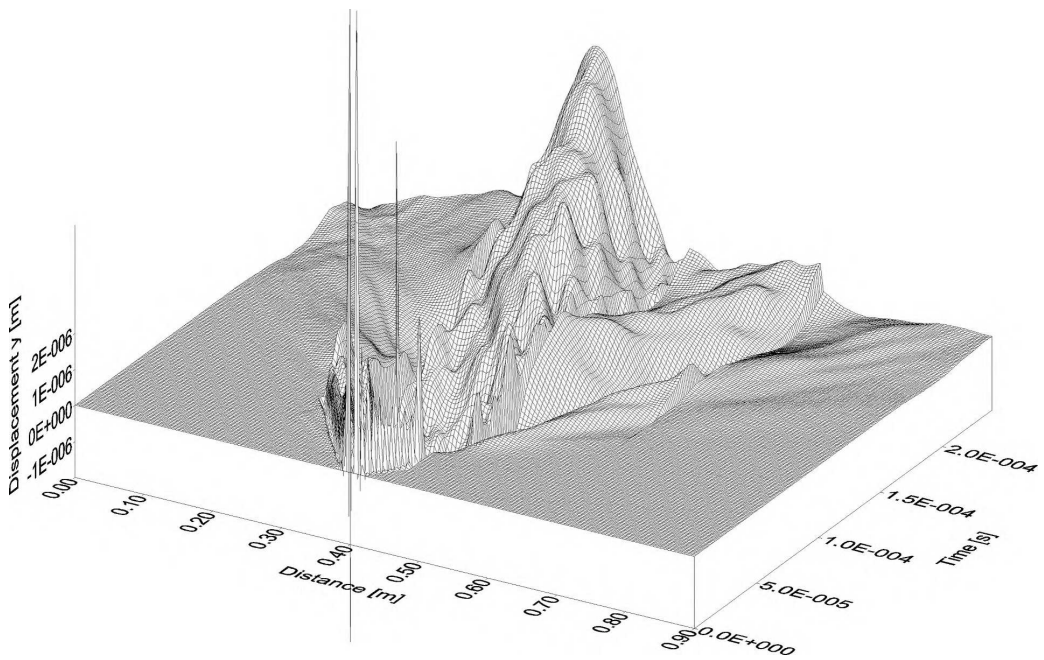
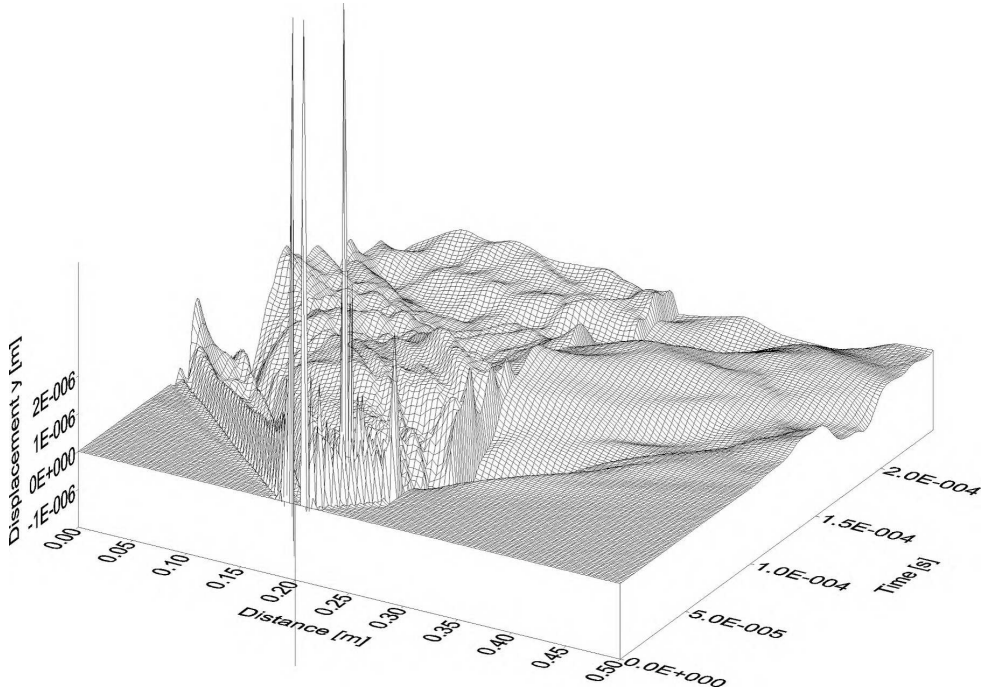

Fig. 5. a) Displacements time histories for the specimens with single rod and with cracks. Excitation at the distance 0.2 m, b) Displacements time histories for the specimens of lattice type and with cracks. Excitation at the distance 0.4 m

Acknowledgements

These works are realized in collaboration with Faculty of Civil Engineering of Technical University in Brno in frame of Czech Grant Agency project nr. 103/06/0891 “*Testing Methods of Massive Reinforced Concrete Structures*” and with Nuclear Research Institute in Řež in frame of research and development program “*Impuls*”, nr. FI-IM/130, stage 2.3 “*Inspection and Checking of Civil Structures*” and are supported by Ministry of Education of Czech Rep. by possibility to use computer clusters of project METACentre, which is realized by CESNET association in frame of research program MSM6383917201 “*Optical Net of National Research and its New Applications*”.

References

- [1] ASTM standard C1383-98a, Standard Test Method for Measuring the P-wave speed and the thickness of Concrete Plates Using the Impact-Echo Method, American Society for Testing and Materials Committee of Standards, PA USA, 1998.
- [2] Copy of part of technical report about concreting at NPP Dukovany, chapter IX. Výroba čerstvé betonové směsi, A – Složení směsi, tab. page. 18.
- [3] K. Anish, et al., Structural integrity assessment of the containment structure of a pressurised heavy water nuclear reactor using impact echo technique. *NDT & E International* 35, Elsevier Science, Ltd., 2002, p. 213–220.
- [4] R. Brepta, Modifikace metody konečných prvků pro nestacionární problémy dynamiky. Studie ČSAV č. 13, Academia, Praha, 1982.
- [5] R. Brepta, Vlastnosti modelu rovinného kontinua vytvořeného pravouhlými nebo rovnostrannými trojúhelníkovými prvky, *Stroj. časopis* 36, č. mbox4–5, Bratislava, 1985.
- [6] V. Červenka, R. Pukl, Atena program documentation. Technical report, Červenka Consulting, Prague, Czech Republic. <http://www.cervenka.cz>, 2005.
- [7] D. Matesová, M. Vořechovský, Modeling of reinforcement corrosion in concrete. National Conference With International Participation Engineering Mechanics 2007, Svratka, Czech Republic, 2007.
- [8] Š. Morávka, Testování možností modelování nestacionárního šíření napěťových vln metodou konečných prvků. Národní konference Inženýrská mechanika'98, Svratka, 1998, s. 489–494.
- [9] Š. Morávka, Porovnání analytického řešení nestacionární rázové napjatosti kontinua s výpočtem pomocí MKP., *Strojnícky čas.* 49, č. 6, Bratislava, 1998, str. 406–425.
- [10] Š. Morávka, Společné posouzení vedlejších účinků časové a prostorové diskretizace při nestacionárním zatížení. Národní konference Inženýrská mechanika '99, Svratka, 1999, str. 391–396.
- [11] Š. Morávka, The Elastic Wave Propagation over the Shape Transitions of Bodies. International Conference Engineering Mechanics 2000, Svratka, Czech Republic, 2000, pp. 133–138.
- [12] Š. Morávka, Porovnání numerického modelu šíření elastických vln v tělesech s výsledky měření piezoelektrickým snímačem. Vliv přítomnosti snímače na měření. 38th International Conference EAN 2001, Tábor, 2001, pp. 231–236.
- [13] Š. Morávka, J. Voldřich, Příspěvek numerické simulace k detekci armování a trhlin v železobetonu. 19. konference s mezinárodní účastí Výpočtová mechanika 2003, Nečtiny, 2003.
- [14] Š. Morávka, J. Voldřich, Application the “Impact-Echo” Method to the Concrete Structure Diagnostic in NPP. National Conference with International Participation Engineering Mechanics 2004, Svratka, Czech Republic, 2004.
- [15] Š. Morávka, J. Voldřich, Numerické modelování diagnostiky různě hlubokých trhlin a plochých dutin betonových konstrukcí J. E. metodou “Impact-echo”. Computational Mechanics 2004, 20th conference with international participation, Nečtiny, Czech Republic, 2004.
- [16] Š. Morávka, Numerická simulace diagnostiky ukloněných povrchových trhlin tlustostěnných betonových konstrukcí JE metodou “Impact-Echo”. Computational Mechanics 2005, 21th conference with international participation, Nečtiny, Czech Republic, 2005.

- [17] Š. Morávka Š., Oblique Inclined Surface Voids Of Thick-Walled Concrete Structures of Nuclear Power Plants — Numerical Simulation Of Impact-Echo Diagnostic Method. National Conference With International Participation Engineering Mechanics 2006, Svratka, Czech Republic, 2006.
- [18] Š. Morávka, Numerická simulace detekce objemných dutin tlustostěnných betonových konstrukcí jaderných elektráren metodou Impact-Echo. Computational Mechanics 2006, 22nd conference with international participation, Nečtiny, Czech Republic, 2006.
- [19] Š. Morávka, Application of the Impact-Echo Diagnostic Method for the Detection of Large Cavities in Thick-Walled Concrete Structures of Nuclear Power Plants. National Conference With International Participation Engineering Mechanics 2007, Svratka, Czech Republic, 2007.
- [20] Š. Morávka, Numerical Simulation of the Impact-Echo Diagnostic Method for the Detection Voids, Crack and Cavities in Thick-Walled Concrete Structures of NPP. International Topical Meeting VVER 2007, Prague, Czech Republic, 2007.
- [21] Š. Morávka, The Proper Filling Confirmation of the Cavities in Massive Concrete Structures of Nuclear Power Plants by Impact-Echo Method. Applied and Computational Mechanics, Vol. 1, No. 1, 2007, pp. 185–192, (23rd conference with international participation, Nečtiny, Czech Republic), 2007.
- [22] Š. Morávka, Impact-Echo Method Application on The Detection of Cavities in Massive Concrete Structures of NPP Repaired by Injecting Mass. National Conference With International Participation Engineering Mechanics 2008, Svratka, Czech Rep., 2008.
- [23] Š. Morávka, Numerical Simulation of the Impact-Echo Diagnostic Method for the Detection Voids, Cracks and Cavities in Thick-Walled Concrete Structures of NPP. OECD-NEA Workshop on Aging Management of Thick Walled Concrete Structures, Prague, Czech Republic, 2008.
- [24] M. Okrouhlík, R. Brepta, Side Effect of Finite Element Method Applied on Stress Wave Propagation in a Thin Elastic Bar, Acta Technica ČSAV, No. 4, Praha, 1976.
- [25] L. Pečínka, Š. Morávka, J. Voldřich, Mathematical Model of the Propagation of P, S and R-Waves in a Concrete Thick Walls with Rebars and Cracks. CSNI/RILEM Workshop on Use and Performance of Concrete in NPP Fuel Cycle Facilities, Madrid, Spain, 2004.
- [26] L. Pečínka, Š. Morávka, J. Voldřich, Lessons Learned From Mathematical Modeling of Detection a Deep Surface Cracks and Internal Voids of Thick Walled Concrete Structures Using Impact-Echo Method. Safety Assurance of Nuclear Power Plants with WWER, The 4th International Conference, Podolsk, Moscow Region, Russia, 2005.
- [27] L. Pečínka, Š. Morávka, J. Voldřich, Numerical Simulation of the NPP's Steel-Concrete Structures Diagnostic by the Impact-Echo Method., 18th International Conference on Structural Mechanics in Reactor Technology (SMiRT 18) Beijing, China, 2005.
- [28] L. Pečínka, Š. Morávka, J. Voldřich, In-service Inspection of Thick Walled Concrete Structures. 31. MPA-seminar and symposium “Materials & Components Behaviour in Energy & Plant Technology”, Materialprüfungsanstalt Universität Stuttgart, Germany, 2005.
- [29] L. Pečínka, Š. Morávka, In-service Inspections of Thick-Walled Concrete Structures. Problemy pročnosti, No. 4/2006, 2006, pp. 64–78, Nacionalnaja Akademia Nauk Ukrainy, Institut Problem Pročnosti NAN imeni G. S. Pisarenka, Kiev, Ukrajina. Translation ed.: Strength of Materials, Springer New York, Vol. 38, Number 4, 2006.
- [30] F. Schubert, Geometrical Effects on Impact-Echo Testing on Finite Concrete Specimens. Symposium NCT-CE Non-Destructive Testing in Civil Engineering 2003, Berlin, Germany, 2003.
- [31] F. Schubert, On the accuracy of thickness measurements in impact-echo testing of finite concrete specimens — numerical and experimental results. Ultrasonics 42, p. 897–901, Elsevier B. V., 2004.
- [32] L. Yiching, et al., A simple device for detecting impact time in impact-echo testing of concrete. NDT & E International 37, Elsevier Science, Ltd., 2004, p. 1–8.