

Comparing the Low-Cost Measuring Devices for Standstill Frequency Response (SSFR) Testing for Electric Machines

Vladimir Pavlicek
Department of Applied Electronics and
Telecommunication
University of West Bohemia
Pilsen, Czech Republic
pavlicek@kae.zcu.cz

Jiri Fort, Martin Pittermann, Bohumil Skala
Department of Electromechanics and Power
Electronics
University of West Bohemia
Pilsen, Czech Republic
pitterma@kev.zcu.cz

Abstract – This paper compares the different versions of hardware realization of low-cost device for standstill frequency response SSFR testing. The SSFR testing is a modern method used for testing and parameter identification for electrical machines especially for synchronous machines (high power generators for power stations). This paper shows the methods how to realize this SSFR testing device for machine identification by general purpose components (to achieve universal device not only for SSFR testing but also for purposes of more universal usage (i.e. measuring of non-linear power systems, power system fault identification, non-symmetrical differences measurement, etc.). This modern method makes it possible to replace the Sudden Short-circuit Measurement Method and thus saves the mechanical construction and lifetime of the machine, which might be otherwise reduced due to the strong dynamic forces that occur in this type of measurement. Proposed devices were realized in university laboratories for purpose of getting acquainted with the practical properties of this method and also for didactic purposes (both in terms of the SSFR method itself and in term of realization of a real equipment with given properties).

Keywords-SSFR, measurement of synchronous machine, parameter estimation, standstill tests, frequency response, DSP

I. INTRODUCTION

Classical original measurement and parameter identification methods for synchronous machines (see for example [1]) use sudden short circuit. But this method brings only approximate values of parameters (it depends on the actual rotor position, on the short current derivation, on the residual value of short circuit impedance, etc.). Second problem of usage of sudden short circuit identification methods is the problem of presence of high dynamic forces which may have a negative effect into machine winding (and which can cause winding mechanical deformation demanding or make cause a shorter lifetime of machine).

A relatively new method of standstill frequency response SSFR testing brings many advantages (e.g. measurement repeatability, possibility of automatization of parameter identification, steady state measuring on zero rotor speed, etc.). But this modern testing method (see [2] – [5] etc.) needs a complicated

and expensive testing device (especially for testing of high power system, synchronous machine etc.).

This paper describes the advantages and disadvantages of several different variants of hardware topologies realizations. All of these variants were realized and tested in university laboratory - with purpose to apply general useful components, to minimized the cost of these developed devices (with comparing of attributes of these different versions of realization), with many possibilities of device modifications along with didactic purposes (standard education of modern technologies together with intensive student collaboration by student thesis).

II. THE PRINCIPLE OF SSFR TESTING

The standstill frequency response (SSFR) testing for synchronous machine use a set of relatively independent measurement tasks. Each of this measurement task takes a large number of measured different values at frequencies in a wide range, e.g. 10mHz to 1kHz. It leads to very long time of measurement. Therefore, this method brings the requirements for the need to implement automatically measurement and post-process data identification.

Second problem is the dimensioning of the output power part of developed device. While the identification of low power systems can use a standard measurement tools such as e.g. spectrum analyzer with tracking generator or other similar tools based on frequency analysis, the measurement of power devices is a little bit tricky and demanding. When focused on SSFR testing of power devices we need to count with a high currents and voltages applied to the measured device. It leads to use a high power output stage or high power amplifier with a high linearity within the wide range of currents, voltages and frequencies.

In case of SSFR testing of synchronous machines for which the proposed methods were developed one might to count with a total power of synchronous machines within the range of tens of kW to tens of megawatts. Preparing a measurement for such a high power devices requires the use of special high power supply sources together with special current and voltage sensors. In our case the problem was solved by using the combination of general purpose power source

(power semiconductor converter), specially developed measuring device and standard personal computer PC, providing set of tasks, such as human-machine interface, management of testing process, storage of measured data, post-processing of the measured data, etc. – see Figure 4 in Chapter IV.

III. THE SSFR TESTING DEVICE WITH MANUAL CONTROL

Figure 1 shows the structure of configuration of initial experiments of SSFR synchronous machine testing in laboratory. This “manual control” SSFR testing device consist of 3 general purpose components (see Figure 1):

- Arbitrary function generator (number 1 in Figure 1).
- Audio amplifier (number 2 in Figure 1).
- Scope (number 3 in Figure 1).

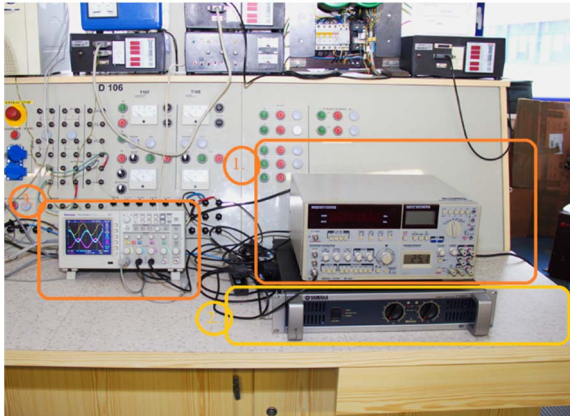

Figure 1. The manual SSFR testing device

Arbitrary function generator (No.1 in Figure 1) was at that time controlled manually (for the purpose of setting appropriate frequencies and magnitudes of testing signals). The output harmonic waves from function generator were amplified by audio amplifier (No.2 in Figure 1) and fed to the power supply terminals of the tested synchronous machine (see Figure 2).



Figure 2. Tested synchronous machine

Output waveforms of currents and voltages were measured by laboratory sensors (current a voltage probes) and were displayed on the oscilloscope (see Fig. 3). These waveforms were manually analyzed (i.e. phase delay and magnitude, resp. impedance magnitude as a current ratios or. voltage/current ratio) and these computed data were storage into the table (in MS/Excel) see [6].

This measuring process takes a great effort, with many potential risks caused by human factor. The high frequency measurements (i.e. tens of Hertz and up) bring a high value of machine-winding impedance and it needs relatively high input voltage to obtain applicable values of current. On the other hand, the low frequency measurement (e.g. tens of mHz) brings low value of machine-winding impedance and it need relatively high input currents to obtain applicable values of output voltage, moreover it requires a long acquisition time of measurement of one low-frequency period and problems with reading accuracy from the scope and its subsequent analysis.

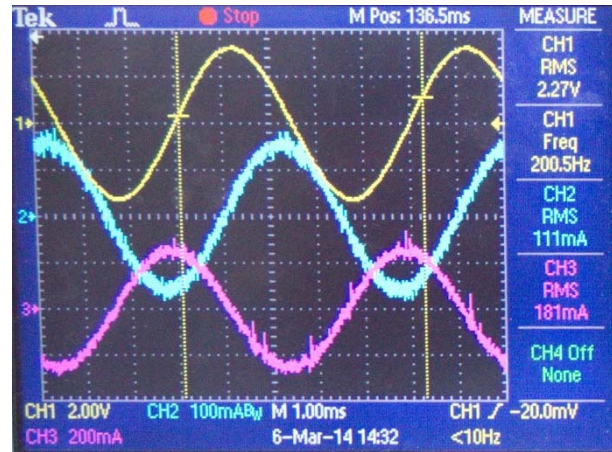

Figure 3. Measured current and voltage of synchronous machine

IV. THE AUTOMATIC SSFR TESTING DEVICE

Figure 4 shows the basic idea of structure for automatic SSFR testing device (see [7]). This “automatic” SSFR testing device consist of 3 general purpose components (see Figure 4):

- Personal computer (master control device which controls testing process, human-machine interface HMI, storage of measured data, post-processing)
- Digital signal processor DSP with special interface (slave control device, which generates waveforms of selected frequency, controls the power converter, measures currents and voltages and compute phase delay and magnitude by DFT analyses).
- Power converter for powering the machine windings with sufficient output voltage and currents.

The serial communication interface SCI between PC and DSP uses a special communication protocol ensuring the minimization of transferred data. The data sent from PC are the frequency, magnitude of the harmonical and values of maximal current limitation. The data sent back to PC from DSP are values of phase delay and magnitude for a given frequency or the error

message. This minimization of data transfer brings the advantages for user, PC can be used for purposes of further data post-processing while running the measurement.

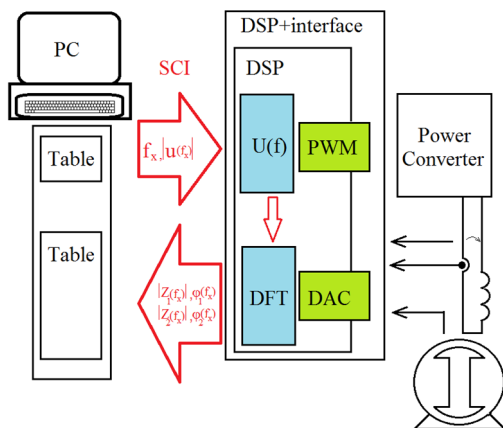

Figure 4. Principle of realised device for SSFR testing.

Figure 5 shows a practical realization of this full automatic SSFR testing device. The power converter is a standard three phase voltage source inverter (used also for another applications - for example for induction machine supply, etc.). Slave control unit is based on DSP Texas Instruments TMS320F2812 (with interface used for laboratory tasks for control of power semiconductor converters). All of these components are general purpose units - only with special software. Software for DSP is written under C/Code Composer and Matlab/Simulink®.

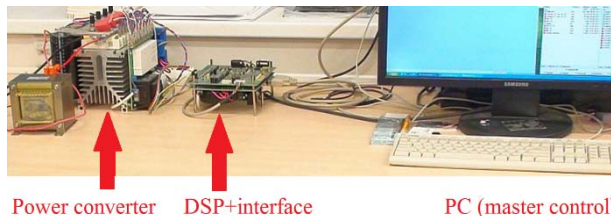

Figure 5. Power converter with IGBT transistors

This “second generation” of developed SSFR testing device brings many advantages – for example automatic function of measurement, high accuracy of phase shift analysis, possibility of using wide frequency area (with high voltage and current limitation). But using of standard high power inverter brings the additional problems for low voltage measurement. Used 1200V IGBT power modules have a relatively high voltage dip (circa 2V per each IGBT-transistor resp. diode) and relatively long dead time (circa 500 ns). These both problems must be solved by computing the voltage dips and dead-time compensation. Next problem is high voltage and current ripple. These problems was solved by using software DFT-filtering and by using reference signal of output voltage (PWM reference signals has lower ripple then measured output inverter voltage).

Next “third generation” of developed SSFR testing device (see Figure 6) uses a power source based on power converter with MOS-FETs transistors (full bridge converter). These transistors bring lower voltage

dips, higher limit of maximal switching frequency (500 kHz) thus reducing the output current ripple. This IC brings the possibility of very compact solution (Texas Instruments DRV 8432 with four half bridges, see [8], [9]). This new “third” generation of SSFR testing device uses a floating point DSP TI TMS320F28335, to ensure the possibility of easy modifications and adding a new, advanced features, such as power system parameter fault identification, measuring of non-linear inductances, etc.

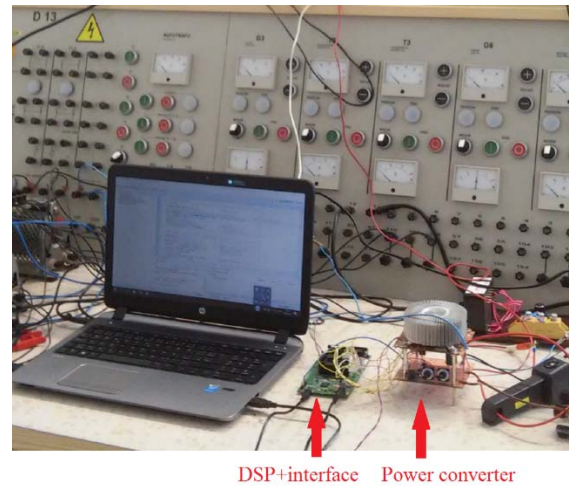

Figure 6. Power converter with MOS-FET transistors.

Figure 6 shows experimental configuration of testing device during development in laboratory.

Figure 7 shows the final compact solution (with DSP, interface and power converter with MOS-FETs) in one small box (150mm x 150 mm x 200mm, continuous output current 14 A, 24 A peak).

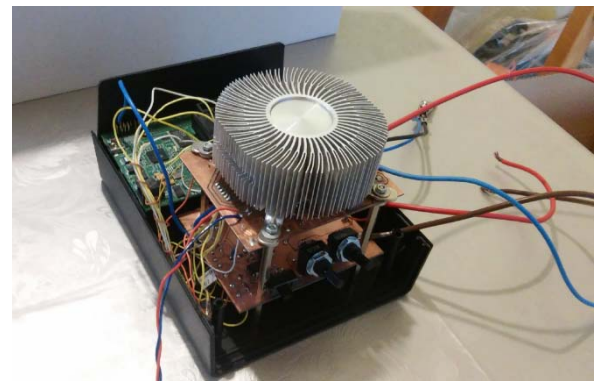

Figure 7. Compact “third generation” of power converter with MOS-FET transistors and with DSP and its interface.

This compact “third generation” of SSFR testing device brings many advantages for low frequency measurements (low output frequency with low current ripple, etc.). High frequency measurements for high impedance systems (i.e. big synchronous machines, etc.), bring certain restrictions and disadvantages due to the higher voltages that must be applied to the input of the measured machine. Both latest developed generations complement each other. While the second generation, with 1200V IGBT drivers, is better for measurements at higher frequencies, because of higher output voltage of amplifier although with higher output ripple, the third generation is better for measurements

at lower frequencies (MOS-FET transistors, lower voltage, lower ripple and noise). Using a unified communication of PC with these two generations of SSFR testing device one might design a system consisting of both systems and take the advantage to measure at low and high frequencies simultaneously, i.e. to design a high accuracy system in a wide frequency range.

Last “fourth generation” uses a semiconductor converter based on linear amplifier. This version reduces the output current ripple, but the maximal output current is limited to a maximal peak value of 12 A. Comparing the “third” and “fourth” generation one might prefer the “third” generation with MOS-FETs transistors. Although using the linear amplifier we are not faced with a switching frequency problems, the high switching frequency of MOS-FET in third generation does not affect the ripple of the voltage and current and thus finally ensures better results with measurements (moreover with a twice power than the fourth generation).

Figure 8 shows the experimental results of measure of synchronous generator in laboratory (8 kW, 10 kVA, 400/231V, 14.5A 1000RPM).

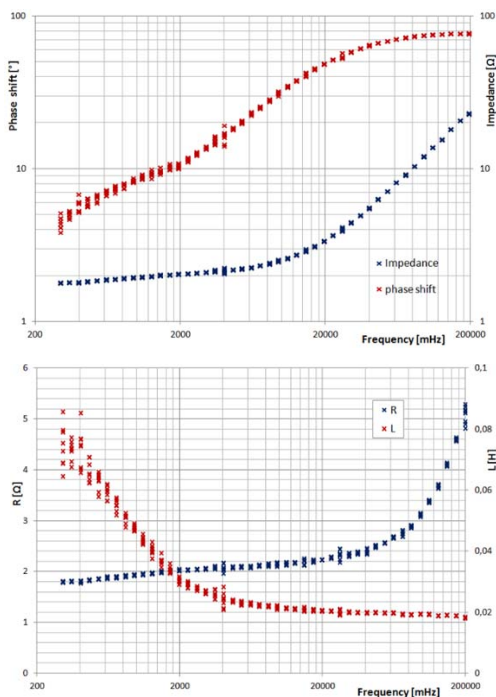

Figure 8. Experimental results of SSFR test of synchronous generator (stator winding impedance, direct axis of rotor position).

Upper image shows the dependence of the magnitude of the impedance and the phase shift depending on the different test frequencies. The image below shows the conversion to equivalent resistance and equivalent inductance in the equivalent circuit of the measured machine, using the fitting method. [1-5, 7]

V. CONCLUSION

This paper compares several variants of developed device for standstill frequency response (SSFR) test for

synchronous machines and other electric machines. This development requirement was initiated by one of our industrial partner. For these purposes a several different variants of SSFR testing devices were developed and compared between each other with attributes. Additionally these prototypes are used for education purposes at our faculty.

Before the actual implementation in the DSP, the control algorithms for controlling the inverter and evaluating the measured data were verified by simulation in the Matlab Simulink© environment. This made it possible to streamline the code generation process and quickly eliminate possible errors.

Further development process of SSFR device will be focused on software upgrade to improve the user environment (see [10]) and optimization of post-process data analysis and to implement advanced signal processing in DSP, such as power-system parameter fault identification, measuring of non-linear inductances, etc.

ACKNOWLEDGMENT

This research has been supported by the Student Grant System “Research and development of electronic and communication systems in scientific and engineering applications” under project SGS-2018-001.

REFERENCES

- [1] F. K. Dalton and A. W. W. Cameron, “Simplified measurement of subtransient and negative sequence reactances in salient-pole synchronous machines,” *Trans. AIEE*, pp. 752–757, 1952
- [2] IEEE Guide Test Procedures for Synchronous Machines, IEEE Std. 115, 7th May, 2010.
- [3] P. L. Dandeno and H. C. Karmaker, “Experience with standstill frequency response (SSFR) testing and analysis of salient pole synchronous machines,” *IEEE Trans. Energy Conversion*, vol. 14, pp. 1209–1217, Dec. 1999.
- [4] S. Henschel and H. W. Dommel, “Noniterative synchronous machine parameter identification from frequency response tests,” *IEEE Trans. Power Syst.*, vol. 14, pp. 553–560, May 1999.
- [5] R. M. Saunders, “Standstill frequency-response methods and salientpole synchronous machines,” *IEEE Trans. Energy Conversion*, vol. 14, pp. 1033–1037, Dec. 1999.
- [6] M. Malek: Synchronous machine steady-measurement, Diploma Thesis, University of West Bohemia Pilsen 2017, 32 pages.
- [7] V. Pavlicek, M. Pittermann, J. Fort, “Development of the Measuring Device for Standstill Frequency Response (SSFR) Testing for Electric Machine“, 2018 18th International Conference on Mechatronics - Mechatronika (ME), 2018, pp. 1 – 6.
- [8] O. Urban: Universal low-power power generator, Diploma Thesis, University of West Bohemia Pilsen 2017, 59 pages.
- [9] DRV84x2 Dual Full-Bridge PWM Motor Driver [online]. Texas Instruments. 1. 12. 2014. Available in address: <http://www.ti.com/lit/ds/symlink/drv8432.pdf>
- [10] S. ENACHE, A. CAMPEANU, I. VLAD and M. ENACHE, "Aspects Regarding Tests of Three-Phase Asynchronous Motors with Single-Phase Supply," 2019 16th Conference on Electrical Machines, Drives and Power Systems (ELMA), Varna, Bulgaria, 2019, pp. 1-6.