



ANOVA analysis for estimating the accuracy and surface roughness of precisely drilled holes of steel 42CrMo4 QT

Jan Řehoř¹ · Jaroslava Fulemová¹ · Jan Kutlwašer¹ · Miroslav Gombár¹ · Marta Harničárová¹  · Milena Kušnerová¹ · Alena Vagaská¹ · Michal Povolný¹ · Jan Valíček¹ · Tomáš Zatloukal¹

Received: 18 November 2022 / Accepted: 14 February 2023 / Published online: 3 March 2023
© The Author(s) 2023

Abstract

The presented publication is focused on increasing the productivity and efficiency of machine production of precision holes. Considerable attention was paid to the influence of the pre-preparation and drilling technology on the quality of the reamed hole. The material selected for machining was chromium-molybdenum steel 42CrMo4 QT. The cluster analysis is implemented to evaluate the experimental results obtained by measuring the cylindricity and surface roughness of the drilled and reamed holes. The factor of hole pre-preparation technology was selected in two quality levels, and the factor of drilling technology in four quality levels. The constant factors were carefully controlled during the experiment, i.e., other possible influences were excluded or minimised. Under constant cutting conditions, the experiment of the subject machining process was carried out. The cutting process parameters investigated were the cylindricity and the roughness of the machined surface *Ra*. The novelty and contribution of this research lie in confirming the assumption that drilling technology influences hole quality primarily, whereas hole pre-preparation technology has a secondary effect.

Keywords Drilling · Reaming · Precision holes · Cylindricity and roughness · Surface integrity

✉ Marta Harničárová
marta.harnicarova@gmail.com

Jan Řehoř
rehoř4@fst.zcu.cz

Jaroslava Fulemová
fulemova@fst.zcu.cz

Jan Kutlwašer
kutlis@fst.zcu.cz

Miroslav Gombár
gombar@fst.zcu.cz

Milena Kušnerová
milena.kusnerova@seznam.cz

Alena Vagaská
vagaskaa@fst.zcu.cz

Michal Povolný
mpovolny@fst.zcu.cz

Jan Valíček
valicekj@fst.zcu.cz

Tomáš Zatloukal
tzatlouk@fst.zcu.cz

1 Introduction

Most scientific research publications focus on evaluating quality parameters after drilling, depending on the choice of material [1–4].

Another important area of the subject is monitoring dynamic phenomena accompanying drilling, which play a significant role in the final assessment of surface integrity and tool wear [5–9]. In [6], a simulation of drilling and reaming is performed using a model that incorporates the effects of the forces imposed by the machine tool-cutting tool-workpiece system [7, 8]. Publications [9–11] concentrate on the effect of vibrations that accompany drilling. Both drilling and reaming are loaded with vibration as a negative factor [9]. In particular, publications [10, 11] deal with the problem of vibration in drilling using a generalised model that addresses the effects of vibration on the tool in terms of tool life and wear time. In addition, the manifestation of vibrations having an adverse effect is the lower quality of the drilled hole.

Similar to drilling, reaming is also monitored for factors that significantly affect the final quality of the hole. The objectives of the publications [12–15] are mainly

¹ Regional Technology Institute, University of West Bohemia, Univerzitni 8, 306 14 Pilsen, Czech Republic

concerned with describing the behaviour and properties of the tool under different reaming conditions with respect to the desired roughness and geometric accuracy. The dependencies investigated are also cutting forces, chip character and chip leakage from the cutting point [14, 15]. In [6], a mathematical model of drilling and reaming is proposed to determine the variation of tool eccentricity due to vibration and the degree of influence on the final hole completion. Paper [7] deals with a technical as well as economic comparison of two manufacturing systems in the drilling of compacted graphite iron: drilling and reaming \times drilling. As part of the technical analysis, they examined the tool wear mechanism, hole quality, and machining time, while the economic analysis focused on the total costs of machining using a specially designed drill and conventional drills followed by reamers. In comparison with reamers, specially designed drills showed lower wear.

Publications dealing with the use of coolant, its quantity, and the pressure applied are numerous. The analysis of experimental results for the choice of different cutting fluid concentrations during reaming is addressed in publications [16, 17]. Publication [17] investigates the performance of the selected cutting fluid in terms of the geometric accuracy of the produced hole and the desired roughness.

Based on the analysis of the current state in the given field of research, it can be stated that the vast majority of publications deal separately with either the drilling technology and accompanying phenomena (e.g., cutting forces, vibration, chip formation) or hole reaming, but only in terms of the selected technology and the set cutting conditions. The main technological factors investigated are the material to be machined, the type of tool and its clamping and the process fluid. The process fluid is mainly concerned with its concentration, the pressure applied, and the method of delivery to the cutting point. The influence of rigidity and machine tool performance is also assessed.

In particular, publications [18–21] deal with the problem by applying an innovative experimental approach, in which the impact of the quality of hole drilling on the quality of the reamed hole is addressed in the context of error chaining in multilevel manufacturing and systematic steps to identify and control the errors involved in the evaluation of the hole after reaming. Simulation models are also presented to assess the described uncertainties in the measurement results [8, 22–24].

Reaming from different angles, as well as the method of tool clamping, the selection of cutting tool materials, and their mutual comparison, have been addressed by authors of publications [25–28] for several years. By using combined drill-reamer bits, the purpose of the paper [29] was to determine the speed and axial feed rate that will reduce the inner surface roughness while maintaining circularity in both robot and CNC drilling reaming operations.

Globally, different production methods and access to quality are used based on the manufacturer's goals, capabilities, and familiarity with the system. It is necessary to measure attributes of the output of a manufacturing process in order to monitor and improve the process. The parameters of every machining process can differ depending on the type of operation and mechanism involved. For typical machining operations such as turning, milling, and drilling, the standard machining parameters that can be controlled are the feed rate, the depth of cut, and the cutting speed. Based on the review, the majority of studies investigated the effect of varying machining performance on the alteration of surface roughness of the workpiece [30–34]. Most of them are concerned with the applied statistical methods to decrease the variability of a product.

The analysis of variance (ANOVA) is one of the most powerful analytic techniques available in statistics. It splits an observed aggregate variability that is found inside the data set. After that, the data should be separated into systematic and random factors. This data set has statistical significance in the systematic factor. Using the ANOVA, the analyst determines how the independent variable influences the dependent variable.

Before the invention of analysis of variance, *t*- and *z*-tests were used instead of ANOVA. Ronald Fisher developed the analysis of variance method in 1918. These tests are an extension of the *z*-test and the *t*-test. *Statistical Methods for Research Workers*, published in 1925, was the first publication to introduce the term ANOVA [35]. Experimental psychology was the primary application of ANOVA in its early days. Later, however, it was expanded to include more complex subjects.

A new generation of optimisation approaches is replacing traditional approaches. Generally, there are three types of approaches to optimisation problems, namely exact methods, heuristic methods, and metaheuristic methods. In an optimisation problem, the best amounts are sought for the decision variables so that the objective function of the problem becomes optimal (e.g., it becomes the minimum value in a minimization problem and vice versa). The heuristic algorithms, however, are extremely case-sensitive, while metaheuristics have a general framework and are easily adapted to a variety of optimisation problems by making minor adjustments. Metaheuristics can produce satisfactory results within a few minutes if the algorithm is well-designed and the parameters are tuned correctly. The crucial part of using metaheuristics for optimizing problems is to devise mechanisms that make the problem understandable to the algorithm's structure [36].

There are various types of metaheuristic algorithms, including local search algorithms (Simulated Annealing, Tabu Search, Variable Neighborhood Search), population-based algorithms (Cuckoo Search Algorithm, Genetic

Algorithms, Ant Colony Optimisation, Particle Swarm Optimisation, Archimedes Optimisation Algorithm), and so on [37]. The main objective of all of these algorithms is to enumerate part of the solution space and to generate new solutions based on the feedback they receive from previous solutions in order to achieve a better solution space. Essentially, the algorithm starts with one initial (in local search algorithms) or set (in population-based algorithms) of solutions and moves along the solution space in an effort to find better solutions, finally reporting the best possible solution [38, 39].

Compared to the selection of publications focusing on drilling or reaming, only a small percentage of authors comprehensively dealt with the problem of the interaction of both technologies. Whether drilling significantly (or how significantly) affects the final quality of the reamed hole still needs to be investigated. In the presented article, it is assumed in principle that the quality parameters of the reamed hole are more significantly affected by the previous technology. In particular, inappropriate choice of cutting conditions, machining technology, and significant tool cutting-edge wear affect surface integrity directly. Reaming cannot completely eliminate the defects caused by the previous technology. However, it is usually the case of the final operation, preceded either by drilling only or by adding another technology, namely reaming or drilling. After drilling, the drilled holes usually have a high roughness of the machined surface or do not have a nominal diameter. While reaming and drilling improve the quality of the drilled hole, the trend in the last few years has been to remove these technologies from the production process. This simplification then increases demands on the drilling technology, dispensing with the finishing operations altogether.

2 Methods

The experimental work was carried out on a DMG MORI-CTX beta 1250 TC4A multifunctional turning centre (Fig. 1).

The workpiece, in the form of a bar stock with dimensions $\varnothing 30 \times 9$, was clamped in a three-jaw chuck (main/headstock spindle). The material selected for machining was chromium-molybdenum steel 42CrMo4 QT (hardened to 1000 MPa). The steel used has a bainitic microstructure and contains a large amount of sulphide oxides. The chemical composition and mechanical properties are given in Table 1.

2.1 Machining tools

Four machining tools were used in the experimental part: a spiral drill, edge shaper, centre drilling tool, and reamer.

Spiral drill



Fig. 1 General view of the multifunctional turning centre DMG MORI-CTX beta 1250 TC4A

specifications: Nachreiner E.3617.1.1180, *VHM - Spiralbohrer mit IK,

5xd 11.8 × 56 × 71 x 118 mm; SD 12.0 HA;

geometry: tip angle 140°;

layer: TiAlN;

clamping: Schunk hydro clamp 206406_03; \varnothing 20 mm; 4814; Tendo E Compaq;

overhang: 72.8 mm;

material: sintered carbide;

experimental conditions:

$v_c = 80 \text{ m} \cdot \text{min}^{-1} \rightarrow n = 2160 \text{ min}^{-1}$;

$f_{ot} = 0.19 \text{ mm} \rightarrow v_f = 410 \text{ mm} \cdot \text{min}^{-1}$.

During the experimental research, a drill with the following characteristics was used for drilling:

- Point angle: 140°
- Helix angle: 30°
- Drill diameter: 11.8 mm
- Flute length: 56 mm
- Body: 71 mm
- Overall length: 118 mm
- Shank diameter: 12 h6

During drilling, Blasocut Combi BC36, with a concentration of 8%, was also used.

Edge shaper

specifications: none; it is a VBD shaper;

geometry: 45° main cutting-edge angle;

layer: TiN;

clamping: ER32 collet clamp;

material: sintered carbide;

experimental conditions:

$v_c = \text{m} \cdot \text{min}^{-1} \rightarrow n = 1500 \text{ min}^{-1}$;

$f_{ot} = \text{mm} \rightarrow v_f = 100 \text{ mm} \cdot \text{min}^{-1}$.

Center drilling tool

specifications: none; it is a monolithic instrument;

Table 1 Chemical composition and mechanical properties of 42CrMo4+QT steel

42CrMo4 + QT	Chemical element analysis [%]	C	Mn	Si	P	S	Cr	Mo	Cu	Al
		0.43	0.85	0.19	0.021	0.020	1.14	0.17	0.24	0.012
	Mechanical properties	Rm [MPa]	Rp 0.2 [MPa]	A [%]		Z [%]		Kv [J] 20°C		
		1036	880	15.1		58		82		

geometry: 45° main cutting-edge angle;
 layer: -
 clamping: hydro clamp;
 experimental conditions:
 $v_c = m \cdot \text{min}^{-1} \rightarrow n = 1725 \text{ min}^{-1}$
 $f_{ot} = \text{mm} \rightarrow v_f = 100 \text{ mm} \cdot \text{min}^{-1}$;
 dimensions of the hole: $\phi 4 \text{ mm} \times 2 \text{ mm}$.
 Reamer
 specifications: internal specifications HAM-FINAL 6320-574 $\phi 12\text{H7}$;
 geometry: 45° main cutting-edge angle;
 layer: -
 clamping: hydro clamp (RC head);
 material: cermet;
 experimental conditions:
 $v_c = 180 \text{ m} \cdot \text{min}^{-1} \rightarrow n = 4775 \text{ min}^{-1}$;
 $f_{ot} = 0.72 \text{ mm} \rightarrow v_f = 3438 \text{ mm} \cdot \text{min}^{-1}$.

2.2 Technological procedure for the production of the reamed hole

All the tools used to produce the desired hole were clamped in the milling spindle. The technological procedure for the production of the reamed hole was as follows:

- A. Alignment of the front (straight blade tipped at 45°);
- B. edge shrinkage $0.5 \times 45^\circ$;
- C. variations in technology;

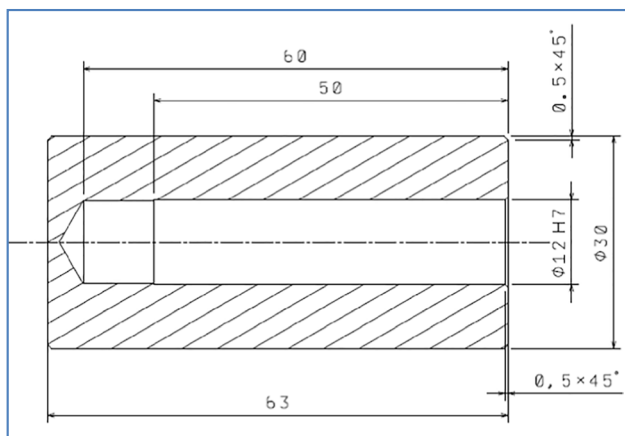

Fig. 2 Reamed specimen

- 0 ... full-length drilling;
- 1 ... drilling the centre hole;
- D drilling a hole $\phi 11.8 \text{ mm}$ to a depth of 60 mm (according to the drawing) + variation of technologies:
- 0 ... working feed;
- 1 ... working feed with interruption after 1D (1 mm rebound);
- 2 ...reduced pilot working feed (50 % up to 0.2 L/D) + working feed;
- 3 ... reduced pilot working feed (50 % up to 0.2 L/D) + working feed with 1D interruption (1 mm rebound);

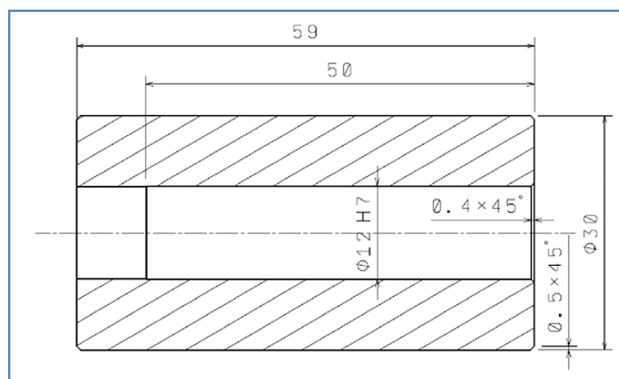

Fig. 3 Specimen for measurement

- E. shrinking the inner edge $0.5 \times 45^\circ$ to $\phi 11.8 \text{ mm}$;
- F. reaming the hole $\phi 12\text{H7}$ to a depth of 50 mm;
- G. pinning the specimen at a distance of 59 mm from the face while simultaneously stepping into the counter spindle;
- H. edge shrinkage $0.5 \times 45^\circ$ to $\phi 30 \text{ mm}$.

The exchange of tools took place in automatic mode. The reamer (Table 2) was clamped in an RC head, which allows controlling the eccentricity of the clamped reamer. For the purpose of the experimental work, the radial run-out (on the reamer cutting edges) was set to 2 μm . Blind/non-passage holes (Fig. 2) were drilled and reamed according to the A-F process described above. For ease of handling, the specimens (in terms of cleaning the inner hole and measurement) were clamped to form a through

Table 2 Specifications of the reamer

Material of the body	sintered carbide
Cutting edge material	cermet
Total length	116 mm
Reamer diameter	12.014 mm
Diameter of the cylindrical shank	10 mm
Shank diameter	9.5 mm
Length of cutting part	5.8 mm
Depth of reaming	4.5 D
Number of cutting edges	6
Helix angle	0°
Chamfer angle	45°
Rake angle	0°
Phase width	0.25 mm
Tooth spacing	60°, 63°, 57°, 60°, 63°, 57°

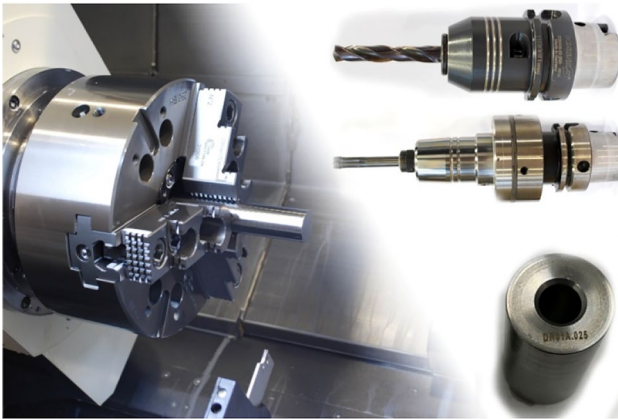
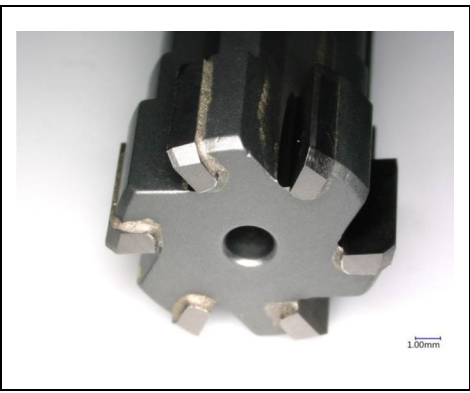
**Fig. 4** View of the machine workspace and the tools used

hole (Fig. 3) according to the procedure G-H mentioned above.

Figure 4 shows the experimental machining system as well as a representation of the workspace of the machine (Fig. 4).

The constant uncontrollable factors were precisely defined, i.e., all instrument parameters were measured and continuously checked during the experiment. The controllable factors, namely hole preparation before drilling (factor 1) and drilling technology (factor 2), were the subject of the experimental investigation. Each factor took on a certain number of levels, with each being qualitative only. In order to carry out the experiment correctly, the machinery and instrumentation used (Table 3) and the plan of the experiment (Table 4) were precisely specified.

2.3 Cylindricity measurement

The first parameter evaluated was the cylindricity of the drilled and reamed holes. The measuring device Taylor Hobson Talysond 585 Lt, manufactured by Taylor Hobson (UK), was used to measure cylindricity. The maximum diameter

of the measured part is 300 mm, with a length of 400 mm. The maximum weight of the measured part is 75 kg, and the measurement accuracy is $\pm 0.01 \mu\text{m}$. When measuring, it is possible to insert contacts with a 0.80 mm, 1.50 mm, and 4.00 mm “ball.” Measuring arms with a tip of $2.00 \mu\text{m}$ and $5.00 \mu\text{m}$ are available for roughness measurement. The cylindricity was evaluated on the basis of 5 measurements carried out on equidistant surfaces. In order to avoid measurement errors, the roughness parameter R_a was measured ten times at each measurement point, which is also desirable with regard to the following statistical data processing. The measurement points for the roughness parameter were identical to the measurement points for the cylindricity measurement. The graph (Fig. 5) clearly shows that the drilling of the centre hole (hole preparation) has a positive effect in the case of the “working feed” drilling technology, up to 1 accuracy class in terms of variation range and almost a quarter lower value compared to the median. This is true both for the cylindricity after drilling and after final reaming.

When comparing the effect of all four technologies for full-length drilling (without drilling the centre hole), it is clear that any interruption of the cut or reduced run-in conditions has a positive impact on reducing the variation margin and increasing the accuracy of the drilled hole after drilling.

The best option for hole quality after drilling appears to be the “non-continuous working feed” technology. In the case of the effect of drilling the centre hole, no effect on accuracy is demonstrated. Only the variation margin is most significant for the “working feed” technology. By comparing the technologies “centre hole drilling” and “full-length drilling,” the influence of the technologies is again not clearly demonstrated.

When comparing the effect of all drilling technologies (hole pre-preparation and preparation before reaming) on the resulting accuracy after reaming, it is clear that in all cases, the accuracy of the holes was improved while the variation margin was significantly reduced. Furthermore, it can be concluded that the “centre hole drilling” technology refines the hole after reaming. Overall, it is clear that the median

Table 3 Specification of machinery and tooling

Machining machine	Type	Name	Year production	Number of axes
Tool – drill	multifunctional machining turning centre	CTX beta 1250 TC 4 A	2015	12
	Milling spindle performance [kW]			
Tool – reamer	2229 (100/40 % ED)			
	Construction	Cutting Material		Clamping
	monolithic	EN	12.000	hydro clamp
	Producer	Dimension	Cover	Feed [mm/rev]
	Nachreiner	ø11.8	TiAlN	0.19
Tool – reamer	Construction	Cutting material	80	Clamping
	VRV reamer with soldered cutting tips	cermet	Cover	RC hydro clamp (eccentricity control)
	Radial run-out [µm]	Cutting edge curvature radius [µm]	-	Feed [mm/ot]
Workpiece	2	8	180	0.72
	Material	Dimension		Clamping
Technology	42CrMo4	ø30Hx550		three-jaw chuck
	Type of hole	Depth of drilled hole [mm]		Depth of a reamed hole [mm]
	blind	60		50
	Reaming pressure [bar]	Drilling pressure [bar]		Concentration [%]
	30	100		8

cylindricity is within a narrow range of accuracy in all cases. It shows that a particular reamer can refine even previous lower-quality holes after drilling. The reamer thus exhibits high stability and reliability.

In terms of the analysis of the investigated parameters of cylindricity of the reamed holes, the Analysis of Variance was used. As a statistical method, ANOVA makes it possible to verify whether the value of a random variable for a specific investigated element is statistically significantly influenced by the value of a feature that can be observed for this element.

2.4 Surface roughness measurement

The second parameter evaluated was surface roughness. A Hommel Etamic T8000, high precision roughness tester, was used to measure the surface roughness of the reamed holes. Each specimen was clamped in a prismatic fixture (Fig. 6), and then the surface roughness R_a , i.e., the mean arithmetic deviation of the profile, was measured on it.

In terms of the analysis of the investigated parameters of the roughness of the reamed holes, the ANOVA statistical method was also used.

3 Results and discussion

The presented article evaluates the machined holes by the achieved accuracy level (IT) and other surface integrity parameters. The measured data were evaluated and presented using graphs and dendrograms.

The charts of the dependence of the cylindricity on the technology used (Fig. 5) express the position of the mean value for the variation range of the measured data in order to subtract the median values for each technology. The magnitude of the variation range can then be used to infer the variability of the values of the investigated numerical variable. At the same time, the boundaries of each accuracy class are inserted in the charts to facilitate the identification of the measurement results. The dendrograms (Fig. 7) present the measurement results in order to read the similarity or dissimilarity of the compared elements.

The STATISTICA 13.5 program was used for the exploratory analysis of the experimentally obtained data regarding cylindricity and roughness, and the Minitab 19.0 program was implemented for the logistic regression analysis.

3.1 ANOVA analysis of variance for cylindricity of drilled and reamed holes

The double-sorting analysis of variance examines the effect of two factors on the investigated dependent variable. We denote these independent variables, the factors,

Table 4 Plan of the experiment

Factor	Level			
	1.	2.	3.	4.
Hole preparation technologies	Full-length drilling DR01A.0XX	Drilling of the centre hole DR01A.1XX		
Drilling technology	working feed	non-continuous working feed (L/D)	reduced working pilot feed (50% up to 0.2xL/D) + working feed	reduced pilot working feed (50% to 0.2xL/D) + non- continuous working feed
	DR01A.X0X	DR01A.X1X	DR01A.X2X	DR01A.X3X

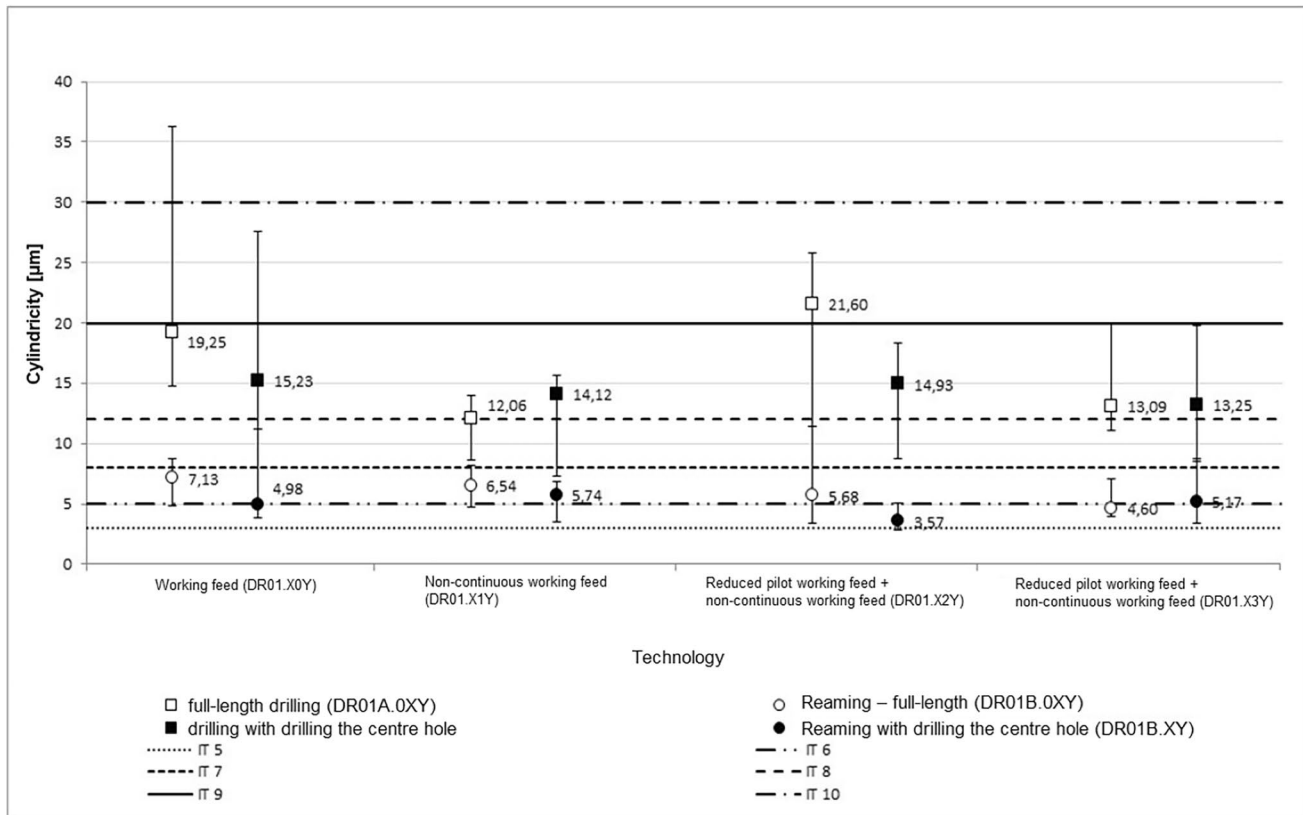

Fig. 5 Effect of selected factors on the cylindricity of the drilled and reamed hole on the applied technology



Fig. 6 Clamped specimen measured with Homel Etamic T8000 profilometer

by the symbols A and B . We also denote a as the number of levels of factor A , and b as the number of levels of factor B . We denote the number of objects corresponding to the i -th level of factor A and the j -th level of factor B by n_{ij} . In order to investigate interactions of factors within the analysis of variance, it is appropriate that n_{ij} be greater than 1. For the measured values of the dependent response variable, we will consider model (1),

$$x_{ijk} = \mu + \alpha_i + \beta_j + \gamma_{ij} + \varepsilon_{ijk} \tag{1}$$

where μ is the common part of the mean of the dependent variable; α_i the effect of factor A at level i ($i = 1, \dots, a$); β_j the effect of factor B at level j ($j = 1, \dots, b$); γ_{ij} the interaction of factor A at level i and factor B at level j ; ε_{ijk} the random error,

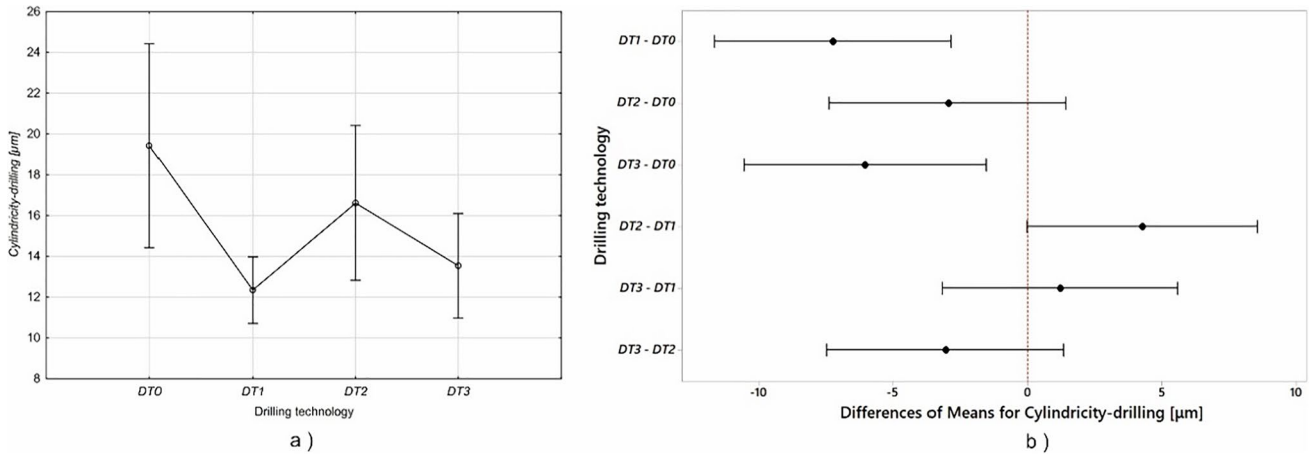

Fig. 7 Effect of drilling technology on the cylindricity of drilled holes

which we assume to have zero mean, normal distribution, and equal variance for all values of i and j .

For each combination of factors, we measure c objects ($k=1, \dots, c$), i.e., all $n_{ij} = c$. We assume that the value of c is greater than 1.

In the analysis, we examine three pairs of hypotheses:

$$H_{01}: \alpha_1 = \alpha_2 = \dots \alpha_a = 0;$$

H_{11} : not all α_i effects are zero;

$$H_{02}: \beta_1 = \beta_2 = \dots \beta_b = 0;$$

H_{12} : not all β_j effects are zero;

H_{03} : there is no interaction between factors A and B (all $\gamma_{ij} = 0$);

H_{13} : some interactions are non-zero.

The construction of the test F-statistic is based on the decomposition of the sum of squares of the measurement deviations from the common mean \bar{x} . The decomposition of the deviation $(x_{ijk} - \bar{x})$ of measurement x_{ijk} from the overall mean \bar{x} is given by (2),

$$(x_{ijk} - \bar{x}) = (x_{ijk} - \bar{x}_{ij.}) + (\bar{x}_{i..} - \bar{x}) + (\bar{x}_{.j.} - \bar{x}) + (\bar{x}_{ij.} - \bar{x}_{i..} - \bar{x}_{.j.} - \bar{x}) \quad (2)$$

where the members represent point estimates of the effects of α_i , β_j , and γ_{ij} .

If we add the squares of both sides of equation (2) for all measurements, after adjustment, we get the relation (3) in the form

$$S_T = \sum_i \sum_j \sum_k (x_{ijk} - \bar{x})^2 = \sum_i \sum_j \sum_k (x_{ijk} - \bar{x}_{ij.})^2 + ac \sum_i (\bar{x}_{i..} - \bar{x})^2 + bc \sum_i (\bar{x}_{.j.} - \bar{x})^2 + c \sum_i \sum_j (\bar{x}_{ij.} - \bar{x}_{i..} - \bar{x}_{.j.} - \bar{x})^2 \quad (3)$$

The relation (3) can be written symbolically as the sum of the individual parts of the total variability (4).

$$S_T = S_e + S_A + S_B + S_I \quad (4)$$

Table 5 Analysis of variance for double sorting

Variability source:	S	Degr. of freedom	MS	F	H_0
Factor A	S_A	$a - 1$	MS_A	MS_A / MS_e	H_{01}
Factor B	S_B	$b - 1$	MS_B	MS_B / MS_e	H_{02}
Interaction	S_I	$(a - 1) \cdot (b - 1)$	MS_I	MS_I / MS_e	H_{03}
Residual	S_e	$ab \cdot (c - 1)$	MS_e		
Total variance	S_T	$abc - 1$			

The sums of squares S_A and S_B capture the main effects of the factors, the sum of S_I their interactions. The sum of squares S_e assesses the within-group measurement variability and is used to estimate the joint variance of the random error ϵ_{ijk} in the analysis of the variance model. The analysis of the variance table (Table 5) contains all the necessary information to obtain the test statistics.

In order to justifiably state that factor A affects the investigated variable X , the null statistical hypothesis H_{03} must be accepted at the chosen level of significance. This guarantees that the effect of factor A at a given level is the same for all levels of factor B .

Based on the results listed in Table 6, it can be argued that all the effects of the independently investigated variable “Preparation before drilling” are null in terms of H_{01} .

Therefore, hole preparation before drilling has no effect on the change in the cylindricity of the drilled hole at the significance level of $\alpha = 5\%$. Similarly, the interaction of hole preparation before drilling and the drilling technology itself is also statistically insignificant in terms of the change in the hole cylindricity value after drilling. However, the change in the hole cylindricity value after drilling is influenced by the drilling technology itself, as evidenced by the significance level achieved of $p = 0.009106$

Table 6 ANOVA results for the cylindricity of the drilled holes

Effect	Univariate Tests of Significance for Cylindricity-drilling [μm]				
	SS	Degr. of freedom	MS	F	p
The Intercept	11007.87	1	11007.87	408.7448	0.000000
Preparation before drilling	49.73	1	49.73	1.8467	0.182176
Drilling technology	358.13	3	119.38	4.4328	0.009106
Preparation before drilling*Drilling technology	89.21	3	29.74	1.1042	0.359361
Error	1023.37	38	26.93		

Table 7 Individual Fisher’s test for differences of the mean for drilling technology

Difference of drilling technology levels	The difference of means	SE of difference	Individual 95% CI	t-value	p-value
DT1 - DT0	-7.24	2.17	(-11.64; -2.85)	-3.34	0.002
DT2 - DT0	-2.97	2.17	(-7.37; 1.42)	-1.37	0.179
DT3 - DT0	-6.04	2.22	(-10.54; -1.54)	-2.72	0.010
DT2 - DT1	4.27	2.12	(-0.02; 8.56)	2.02	0.051
DT3 - DT1	1.20	2.17	(-3.19; 5.60)	0.55	0.583
DT3 - DT2	-3.07	2.17	(-7.46; 1.33)	-1.41	0.166

(Table 6), which is calculated based on Fisher’s test for this effect [40–42].

For the investigated effect of the technology, a uniform designation was used:

PBD0	drilling in solid material
PBD1	drilling the centre hole
PBD2	pilot hole milling
DT0	drilling by working feed
DT1	drilling with interruption after 1D
DT2	reduced working feed to 50% to a depth of 12 mm
DT3	reduced working feed to 50% to a depth of 6 mm + drilling with interruption after 1D;
*	significant at the $\alpha = 5\%$ significance level.

Figure 7 represents the influence of the drilling technology used on the cylindricity of the drilled holes, i.e., the dependence of cylindrical drilling on the drilling technology (Fig. 7a) and the dependence of the drilling technology on the different means selected for cylindrical drilling (Fig. 7b). Based on the previous conclusion (concerning the significant influence of drilling technology on the cylindricity of the drilled hole (Fig. 7a)), it is evident that regardless of the hole pre-preparation technology before drilling, the largest values of the cylindricity of the hole after drilling, with an average value of 19.417 μm , is achieved when drilling with a working feed. It is

followed by cylindricity when drilling with a reduced working feed to 50% to a depth of 12 mm and then drilling with a working feed with an average cylindricity value of 16.608 μm . The lowest value of cylindricity is observed for the drilled hole, with an average value of 12.339 μm when drilling with 1D interruption. However, due to the statistical insignificance of the interaction between the hole pre-preparation technology before drilling and the drilling technology itself, it is also necessary to verify the differences between the experimentally obtained values of the drilled hole cylindricity by individual Fisher’s test (Table 7).

Table 7 shows that significant differences in the mean values of the drilled hole cylindricity at the chosen level of significance $\alpha = 5\%$ are observed for the selected drilling technology DT1 and technology DT0 with the differential value at the level of -7.24 μm . Another significant difference in the hole cylindricity value after drilling is observed for the selected drilling technology DT3 and DT0. According to Table 5, the other compared technologies can be considered identical in terms of statistical inference. Therefore, the measured differences in cylindricity between the technologies can only be attributed to chance. Based on the above analyses of the change in the drilled hole cylindricity values depending on the selected hole pre-preparation technology before drilling and the selected drilling technology, a regression model can be constructed in terms of relation (1) with an extension to include the influence of the individual hole preparation and drilling technologies. Table 8 shows that

Table 8 Individual Fisher’s test for differences of the mean for drilling technology

Term	Coef	SE Coef	95% CI	t-value	p-value
Constant	15.518	0.768	(13.964; 17.071)	20.22	0.000*
Preparation before drilling (PBD)					
PBD0	1.043	0.768	(-0.511; 2.597)	1.36	0.182
PBD1	-1.043	0.768	(-2.597; 0.511)	-1.36	0.182
Drilling technology (DT)					
DT0	4.06	1.35	(1.33; 6.80)	3.01	0.005*
DT1	-3.18	1.31	(-5.83; -0.53)	-2.43	0.020*
DT2	1.09	1.31	(-1.56; 3.74)	0.83	0.409
DT3	-1.98	1.35	(-4.71; 0.76)	-1.46	0.152
Preparation before drilling*Drilling technology					
PBD0-DT0	0.76	1.35	(-1.98; 3.49)	0.56	0.579
PBD0-DT1	-1.64	1.31	(-4.28; 1.01)	-1.25	0.219
PBD0-DT2	1.84	1.31	(-0.81; 4.49)	1.41	0.167
PBD0-DT3	-0.96	1.35	(-3.70; 1.77)	-0.71	0.480
PBD1-DT0	-0.76	1.35	(-3.49; 1.98)	-0.56	0.579
PBD1-DT1	1.64	1.31	(-1.01; 4.28)	1.25	0.219
PBD1-DT2	-1.84	1.31	(-4.49; 0.81)	-1.41	0.167
PBD1-DT3	0.96	1.35	(-1.77; 3.70)	0.71	0.480

Table 9 ANOVA results for the cylindricity of the reamed holes

Effect	Univariate tests of significance for <i>Cylindricity-reaming</i> [μm]				
	SS	Degr. of Freedom	MS	F	p
Intercept	1395.081	1	1395.081	515.5424	0.000000
Preparation before drilling	7.326	1	7.326	2.7073	0.108137
Drilling technology	31.235	3	10.412	3.8475	0.016882
Preparation before drilling*Drilling technology	8.006	3	2.669	0.9862	0.409568
Error	102.830	38	2.706		

only the drilling technology *DT0* and drilling technology *DT1* cause a statistically significant change in the value of the cylindricity (at the chosen confidence interval of $\alpha = 0.05$). From this table, it is clear that the most significant parameter of the regression model is the intercept, which indicates that other influences, which were not considered under investigation in the study, are also largely responsible for the change in the cylindricity value.

If the relationship (1) and the results presented in Table 8 are taken into account, the dependence of the cylindricity of the drilled hole (5) can be predicted in the following way:

$$\begin{aligned}
 \text{Cylindricity} - \text{drilling} = & 15.518 + 1.043 \cdot PBD0 - 1.043 \cdot PBD1 + 4.06 \cdot DT0 - 3.18 \cdot DT1 - \\
 & - 1.09 \cdot DT2 - 1.98 \cdot DT3 + 0.76 \cdot PBD0 \cdot DT3 - 1.64 \cdot PBD0 \cdot DT1 + 1.84 \cdot PBD0 \cdot DT2 - \\
 & - 0.96 \cdot PBD0 \cdot DT3 - 0.76 \cdot PBD1 \cdot DT0 + 1.64 \cdot PBD1 \cdot DT1 - 1.84 \cdot PBD1 \cdot DT2
 \end{aligned} \tag{5}$$

Based on Table 9, it can be further argued that all the effects of the investigated independent variable “Preparation before drilling” are zero in terms of H_{01} , i.e., hole preparation before drilling has no effect on the change in the cylindricity of the reamed hole at the significance level of $\alpha = 5\%$. Similarly, the interaction of hole preparation before drilling and the drilling technology itself is also statistically insignificant in terms of the change in the value of hole cylindricity after drilling. However, the change in the hole cylindricity value after reaming is influenced by the drilling technology itself, as evidenced by the significance level achieved of $p = 0.016882$ (Table 9) for this effect, calculated based on Fisher’s test.

Suppose we extend the analysis of variance of the dependent variable of reamed hole cylindricity to include hole cylindricity measured after drilling (Table 10). In that case, we can see that reamed hole cylindricity is not affected by hole cylindricity after drilling with a significance level of $p = 0.174164$ achieved at the chosen level of significance of $\alpha = 5\%$.

The highest value of the cylindricity of the reamed holes was obtained in the *DT0* technology with a mean value of $6.578 \mu\text{m}$ (Fig. 8a). When using the *DT1* drilling technology, the average value of the reamed hole cylindricity was

$5.962 \mu\text{m}$, while the lowest average value of the reamed hole cylindricity was obtained when using the *DT2* drilling technology. The average value of the reamed object cylindricity in this technology was $4.307 \mu\text{m}$.

When comparing the different drilling technologies (Fig. 8b, Table 11) with respect to the validity of H_{03} , it can be seen that the significant difference in the reamed hole cylindricity values at the chosen confidence interval of $\alpha = 0.05$ is between the *DT2* and *DT0* technologies with a differential value of $-2.271 \mu\text{m}$ at the achieved significance level of the individual Fisher’s test $p = 0.003$ and between the drilling technologies *DT2* and *DT1* with

Table 10 ANOVA results for the individual factors of the extended reamed hole cylindricity model

Effect	Parameter	SS	F	p
Preparation before drilling		6.632489112	2.054124219	0.1587061
Drilling technology		31.23457038	3.72258078	0.01787047
Cylindricity – drilling [μm]	0.071044902	6.044177046	1.906568756	0.174164638

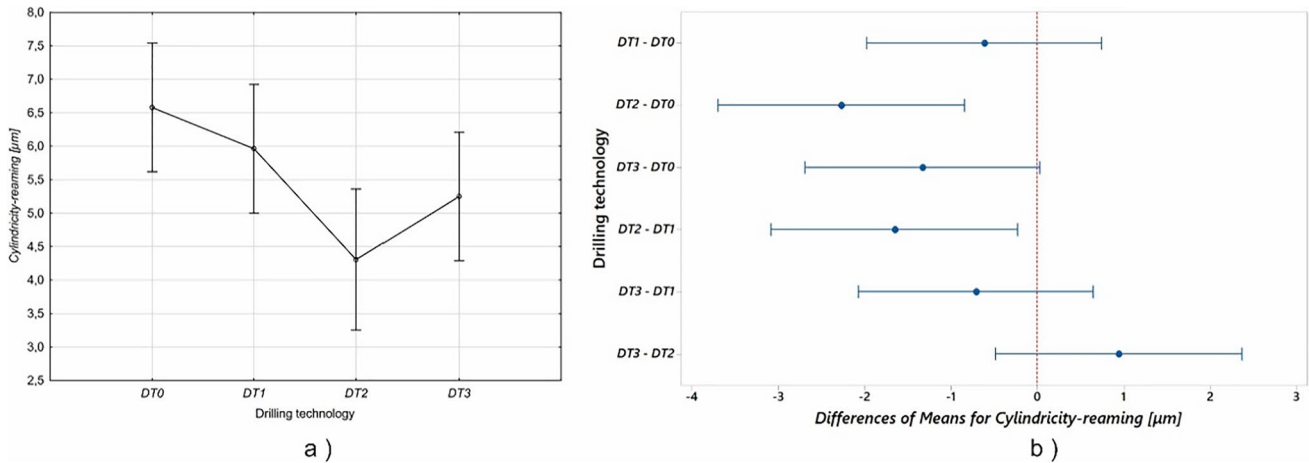

Fig. 8 Effect of drilling technology on the cylindricity of reamed holes

Table 11 The individual Fisher’s test for differences of mean cylindricity of reamed holes for drilling technology

Difference of drilling technology levels	Difference of means	SE of difference	Individual 95% CI	t-value	p-value
DT1 - DT0	-0.617	0.672	(-1.976; 0.743)	-0.92	0.364
DT2 - DT0	-2.271	0.704	(-3.697; -0.845)	-3.22	0.003*
DT3 - DT0	-1.331	0.672	(-2.690; 0.029)	-1.98	0.055
DT2 - DT1	-1.654	0.704	(-3.080; -0.229)	-2.35	0.024*
DT3 - DT1	-0.714	0.672	(-2.073; 0.646)	-1.06	0.295
DT3 - DT2	0.941	0.704	(-0.485; 2.367)	1.34	0.190

a differential value of $-1.654 \mu\text{m}$ at the achieved significance level of the individual Fisher’s test $p = 0.024$.

The measured values of the cylindricity of the reamed holes for individual trials of the implemented experiment (Table 12) can be classified into accuracy classes IT10 to IT12. If the measured value of the cylindricity of the reamed hole for a given test is smaller than the table value for a specific accuracy class in Table 12, then we assign the value 1 to the individual test result. Otherwise, if the measured value of the cylindricity of the reamed hole exceeds the table value of cylindricity for the given class accuracy, we assign a value of zero to the result of an individual trial. In this way, we will convert the measured dependent variable (the cylindricity of the reinforced hole) into an ordinal dichotomous scale. So, we can apply binary logistic regression analysis.

Logistic regression is used in modelling the probability of the investigated variable depending on the value of the interval or categorical variable. The random investigated variable

is assumed to have a binomial distribution with parameter π , which corresponds to the probability of the outcome “1” and varies monotonically with the value of the independent variable. The resulting model is just an estimate of this parameter as a function of x . The use of the logistic model is very broad and covers a number of very different fields. In logistic regression, the probability depending on the variable x is modelled using the logistic model (6), or after adjustment (7).

$$\pi(x) = \frac{\exp(\alpha + \beta x)}{1 + \exp(\alpha + \beta x)} \tag{6}$$

$$\log \frac{\pi(x)}{1 - \pi(x)} = \alpha + \beta x \tag{7}$$

The expression $\log(\pi(x)/1 - \pi(x))$ is called the logit. The values of α and β are the regression coefficients, and

Table 12 Tolerances in relation to the accuracy class of reamed holes

Accuracy class	Circularity[μm]	Rollability[μm]	Mean[μm]	Ra[μm]
IT10	30	30	70	3.2
IT9	20	20	43	3.2
IT8	12	12	27	1.6
IT7	8	8	18	0.8
IT6	5	5	11	0.8
IT5	3	3	8	0.4
IT4	2	2	5	unspecified
IT3	1,2	1,2	3	unspecified

the least squares method is used to estimate a and b . This method produces maximum likelihood estimates of α and β . The logistic regression model can be constructed by a sigmoidal curve $\pi(x)$, which expresses the probability estimation of dependence of the observed phenomenon on x . This model can be used to predict the probability or risk at set values of x . The independent variable x can also be multivariate $\mathbf{x} = (x_1, \dots, x_m)$. The corresponding model has a shape analogous to linear regression (8).

$$\pi(x) = \frac{\exp(\alpha + \beta_1x_1 + \beta_2x_2 + \dots + \beta_mx_m)}{1 + \exp(\alpha + \beta_1x_1 + \beta_2x_2 + \dots + \beta_mx_m)} \tag{8}$$

If we consider the accuracy class of the reamed holes in terms of their cylindricity in the sense of Table 12, the accuracy class IT10 to IT8 includes the results of all realised experiments; therefore, the binary dependent variable IT10 to IT8 in terms of coding of the logistic regression takes the value 1 (the phenomenon occurred). For the purpose of modelling the probability of inclusion of a reamed hole in the accuracy class, we use accuracy class IT6. The basic indicators of the logistic model are shown in Table 13.

Table 14 shows the estimates of the regression coefficients (Term), i.e., their directives, estimates of their standard deviations, 95% confidence intervals of the regression coefficient estimates and the calculated significance levels p . The regression parameter of each trait, i.e., the independent variable, is an estimate of the change in the logistic regression function if there is a unit change in the feature in question, assuming that the other features are held constant.

Thus, the logistic regression model found for the dependent variable of precision class IT6 (if we can classify a given experiment into this class) occurs for state 1, i.e., we can write (9), (10).

$$IT6(1) = \frac{\exp(Y')}{1 + \exp(Y')} \tag{9}$$

$$Y' = 3.67 - 0.301 \cdot \text{Cylindricity}(\text{drilling}) + 0.000 \cdot \text{PBD0} + 0.736 \cdot \text{PBD1} + 0.000 \cdot \text{DT0} - 1.410 \cdot \text{DT1} + 3.660 \cdot \text{DT2} + 0.360 \cdot \text{DT3} \tag{10}$$

Table 13 Input values of the investigated variable IT6

Variable	Value	Count	
IT6	1	22	(Event)
	0	24	
	Total	46	

Table 14 Estimates of the regression coefficients of the logistic model for the cylindricity of reamed holes for accuracy class IT6

Term	Coef	SE Coef	95% CI	Z-value	p-value
Constant	3.67	1.92	(-0.09; 7.43)	1.91	0.056
Cylindricity-drilling [μm]	-0.301	0.117	(-0.530; -0.072)	-2.58	0.010*
Preparation before drilling					
PBD1	0.763	0.786	(-0.778; 2.303)	0.97	0.332
Drilling technology					
DT1	-1.41	1.08	(-3.53; 0.72)	-1.30	0.195
DT2	3.66	1.60	(0.52; 6.80)	2.28	0.022*
DT3	0.36	1.04	(-1.67; 2.39)	0.35	0.729

Based on Table 14, it can be concluded that the classification of the reamed hole based on the cylindricity value into accuracy class IT6 at the significance level $\alpha = 5\%$ is influenced by the drilling technology DT2 used and the cylindricity value achieved during drilling.

From Fig. 9, Table 14, and the relation (10), it can be seen that increasing the value of the reamed hole cylindricity before reaming by 1 μm decreases the probability of the reamed hole being classified in accuracy class IT6 by 35.12%. We can also see that a higher probability of achieving accuracy class IT6 in terms of reamed hole cylindricity is achieved with the PBD1 pre-drilling hole pre-preparation technology, although this conclusion is not statistically significant. In terms of the selected drilling technology, the use of the DT2 technology increases the probability of the hole being classified in the IT6 accuracy class by a factor of 38 compared to the use of the DT0

Fig. 9 Chart of main effects for accuracy class IT6

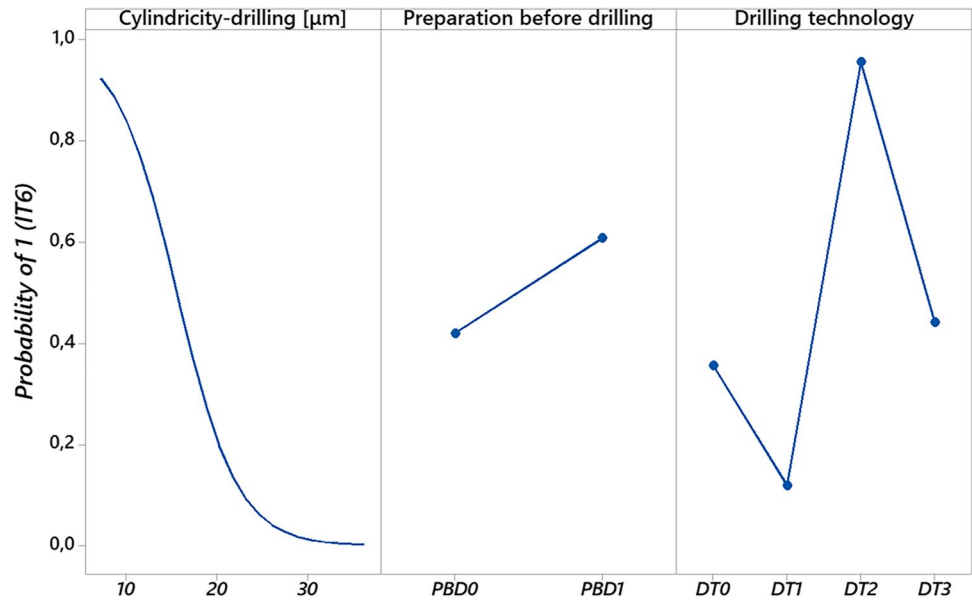

Table 15 Odds ratios for categorical predictors of the logistic model (9) and (10). The odds ratio for level A relative to level B

Level A	Level B	Odds ratio	95% CI
Preparation before drilling			
<i>PBD1</i>	<i>PBD0</i>	2.1436	(0.4594; 10.0032)
Drilling technology			
<i>DT1</i>	<i>DT0</i>	0.2452	(0.0293; 2.0531)
<i>DT2</i>	<i>DT0</i>	38.8492	(1.6803; 898.1819)
<i>DT3</i>	<i>DT0</i>	1.4318	(0.1879; 10.9104)
<i>DT2</i>	<i>DT1</i>	158.4310	(5.2550; 4776.4547)
<i>DT3</i>	<i>DT1</i>	5.8391	(0.8730; 39.0537)
<i>DT3</i>	<i>DT2</i>	0.0369	(0.0015; 0.8835)

drilling technology, which is considered the drilling technology reference in the model (9) and (10). The ratio of the “chances” for the categorical variables of the logistic model (9) and (10) to classify the reamed hole into accuracy class IT6 based on the cylindricity of the reamed hole is shown in Table 15.

Table 15 shows that using the PBD1 pre-drilling hole pre-preparation technology increases the probability that a reamed hole will be classified in the IT6 accuracy class in terms of its cylindricity by a factor of 2.14 compared to the use of the PBD0 pre-drilling technology. In terms of the pre-reaming technology itself, the probability of being able to classify the reamed hole into accuracy class IT6 based on the cylindricity index is only 0.24 times higher when using the DT1 technology than when using the DT0 technology. Significant differences are seen when using the DT2 and DT0 drilling technologies, with the difference being more than 38 times greater and even 158 times more significant when

comparing the DT2 to DT1 technologies. The quality of the tightness of the translation is demonstrated by three tests: the Pearson test, the deviance test, and the Hosmer-Lemeshow test. A large χ^2 value indicates poor model translation and, thus, low calculated significance level p values. The goodness-of-fit tests, with their relatively high calculated significance levels $p = 0.357$ and $p = 0.493$ (Table 16), show sufficient evidence for the proposed model to translate the data adequately. Indeed, if the p -value is less than the selected significance level $\alpha = 5\%$, the test demonstrates poor and inadequate data translation.

Table 17 declares the number and percentage of concordance, discordance, and tied pairs and the correlation matrix evaluation statistics. These measures capture the association between the given and calculated probabilities. The results of this table are evaluated by matching measurements with different values of the dependent variable. From 22 experiments where, based on the cylindricity value, the reamed hole was classified into the group of accuracy class IT6, and 24 experiments where, based on the cylindricity value, the reamed hole was not classified into the group of accuracy class IT6, 528 pairs with different values of the dependent variable will arise. According to this scheme, we consider a pair as concordant if the experiment classifies the reamed hole into accuracy class IT6 based on the cylindricity, i.e., it has a higher probability of being in accuracy class IT6, and we consider it as discordant if the opposite is true. In our case, 86.6% of the pairs are concordant, and 13.1% are discordant.

Somers’ criterion D, Goodman-Kruskal’s criterion gamma, and Kendall’s criterion tau capture the concordance or discordance of these pairs. These measures lie between the values of 0 and 1, and larger values indicate that the

Table 16 Goodness-of-fit test of the model used in (9) and (10)

Test	<i>DF</i>	<i>Chi-Square</i>	<i>p-value</i>
Deviance	40	42.66	0.357
Pearson	40	39.50	0.493
Hosmer-Lemeshow	8	7.60	0.473

Table 17 Logistic model association rates for the cylindricity of the reamed hole (accuracy class IT6)

Pairs	Number	Per cent	Summary measures	Value
Concordant	457	86.6	Somers' D	0.73
Discordant	69	13.1	Goodman-Kruskal Gamma	0.74
Ties	2	0.40	Kendall's Tau-a	0.37
Total	528	100.0		

model has a better predictive ability. In our case, the values lie in the interval of 0.73 to 0.37, demonstrating the sufficient predictive ability of the model.

3.2 ANOVA analysis of variance for drilled and reamed hole roughness

The second evaluated parameter is the roughness of the machined surface Ra , i.e., the average arithmetic deviation of the profile. The evaluated parameter is dependent on many variable factors, such as machining technology, physical and mechanical properties of the material to be machined, quality, shape and geometry of the cutting tool cutting-edge, cutting-edge wear, cutting conditions (especially cutting speeds), stiffness of the machine tool-cutting tool-workpiece system, process fluid, etc. The following graphs show the effect of selected factors on the roughness of the drilled and reamed hole, both when drilling into a solid material (Fig. 10) and when drilling with a pre-drilled centre hole (Fig. 11). From the results shown, it is clear that the numerical values of Ra obtained after drilling can be classified as fine machining. By subsequently reaming these holes, a reduction in the variation margin as well as in the position of the mean Ra value was achieved in all cases.

Furthermore, it can be observed that the most significant variation range of roughness and median is observed in the case of the “working feed” technology. On the other hand, the lowest median and variation margin is observed for the “non-continuous working feed” technology. In both cases, the effect of the hole pre-preparation technology is not demonstrated. Suppose we use Fisher's analysis of variance (ANOVA) methodology to determine the influential input factors on the change in the value of the dependent variable Ra (Table 18). In that case, we can see that in terms of the

defined hypotheses H_{01} , H_{02} , and H_{03} , the value of the roughness parameter Ra of the drilled holes is influenced by the preparation before drilling with a significance value of $p = 0.000363$, the drilling technology itself with the achieved significance level of $p = 0.000000$, as well as the interaction of pre-drilling preparation and drilling technology with the achieved significance level of $p = 0.000000$.

When we analyse the influence of the individual input variables (Fig. 12) in more depth using the individual Fisher test (Table 19), we can see (observe) that the lowest values of the roughness parameter Ra are obtained for the selected pre-drilling preparation technology $PBD0$ with an average value of $Ra = 0.369 \mu\text{m}$. When using the pre-drilling hole pre-preparation technology $PBD1$, the average value of the drilled hole roughness parameter $Ra = 0.425 \mu\text{m}$, and when using the technology $PBD2$, the average value of $Ra = 0.448 \mu\text{m}$.

Table 19 shows that a statistically significant difference in the achieved value of the roughness parameter Ra of the drilled holes at the selected significance level $\alpha = 5\%$ is demonstrated between the pre-drilling hole pre-preparation technology $PBD1$ and $PBD0$ with a differential value of $0.0543 \mu\text{m}$ and between the technologies $PBD2$ and $PBD0$ with a differential value of $0.0796 \mu\text{m}$.

When analyzing the effect of the drilling technology itself on the change in the value of the drilled hole roughness parameter Ra (Fig. 13), it is evident that the highest Ra value was obtained using the $DT0$ drilling technology, with an average value of $0.538 \mu\text{m}$. When using the $DT1$ drilling technology, the average value of the investigated parameter Ra was $0.376 \mu\text{m}$. The lowest values of the roughness parameter Ra were obtained when using the $DT3$ drilling technology, namely $0.336 \mu\text{m}$.

Comparing Fisher's individual test of the different drilling technologies with respect to the achieved value of the drilled hole roughness parameter Ra (Table 20), we can see that the significant difference at the selected significance level $\alpha = 5\%$ is between the selected drilling technology $DT1$ and $DT0$ with a differential value of $-0.151 \mu\text{m}$, between the technology $DT2$ and $DT0$ with a differential value of $-0.119 \mu\text{m}$, between the technology $DT3$ and $DT0$ with a differential value of $-0.192 \mu\text{m}$, and between the technologies $DT3$ and $DT2$ with a differential value of $-0.072 \mu\text{m}$.

The effect of the interaction of the hole pre-preparation technology before drilling and the drilling technology itself on the value of the investigated roughness parameter Ra is shown in Fig. 14.

Figure 14 shows that for the hole pre-preparation technology $PBD0$, the differences in the average value of the investigated roughness parameter Ra depending on the drilling technology used are minimal and range from $0.311 \mu\text{m}$ for the drilling technology $DT3$ to a value of $0.407 \mu\text{m}$ for

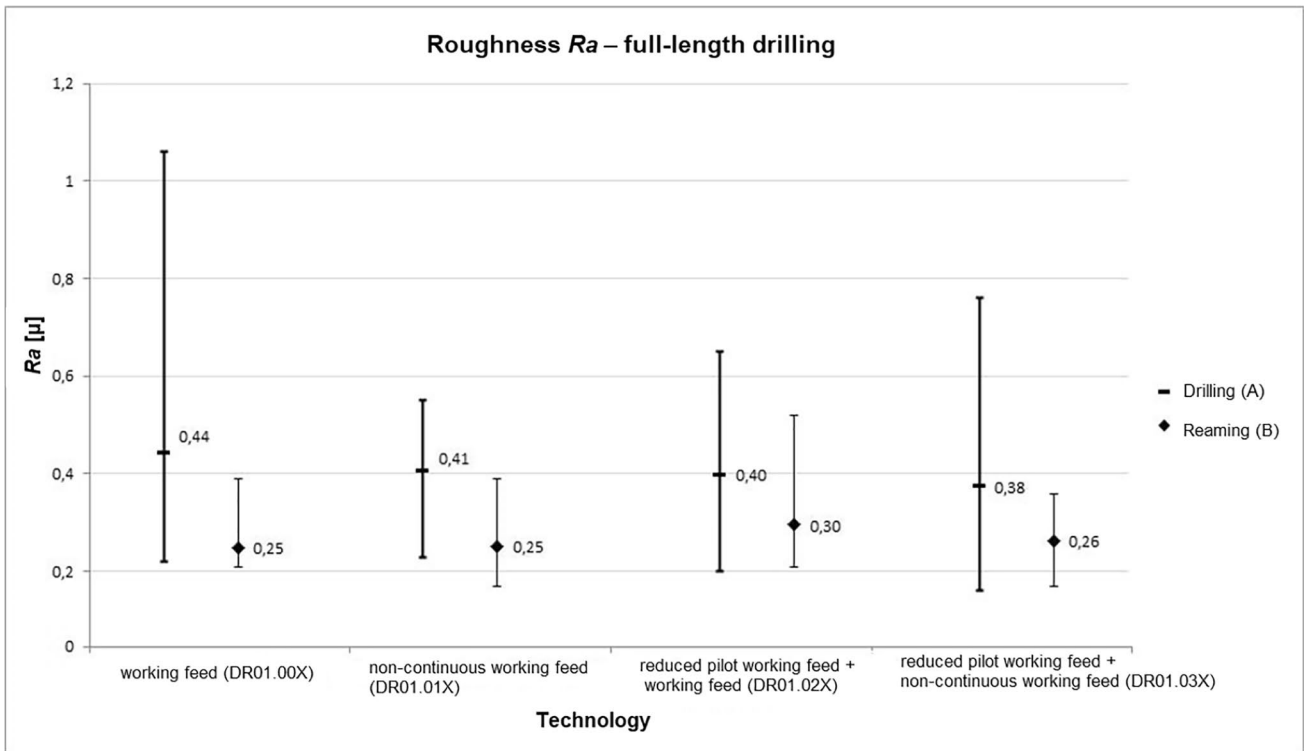

Fig. 10 Effect of selected factors on the roughness of the drilled and reamed hole when drilling into solid material

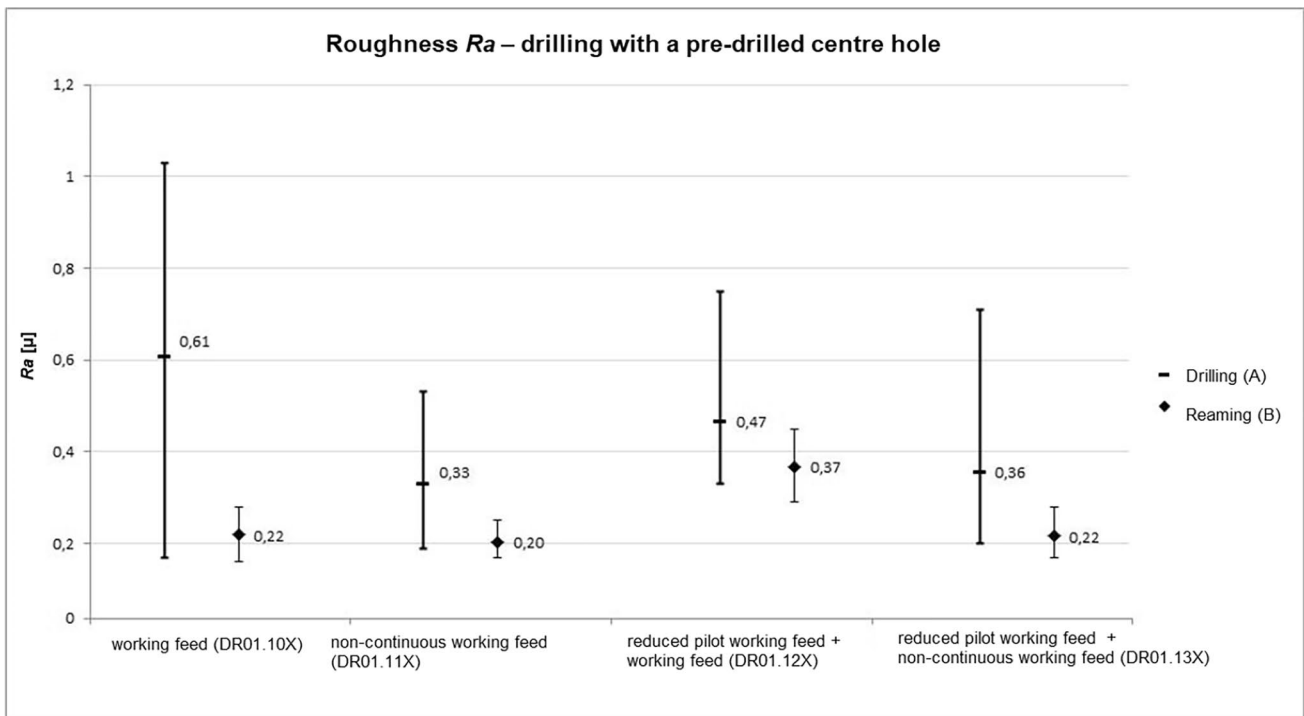

Fig. 11 Effect of selected factors on the roughness of drilled and reamed holes, when drilling with a pre-drilled center hole

Table 18 ANOVA results for *Ra* of the drilled holes

Effect	Univariate tests of significance for <i>Ra</i> [μm]				
	<i>SS</i>	Degr. of freedom	<i>MS</i>	<i>F</i>	<i>p</i>
Intercept	44.92369	1	44.92369	2500.099	0.000000*
Preparation before drilling	0.29367	2	0.14683	8.172	0.000363*
Drilling technology	1.37213	3	0.45738	25.454	0.000000*
Preparation before drilling*Drilling technology	0.86388	6	0.14398	8.013	0.000000*
Error	4.60000	256	0.01797		

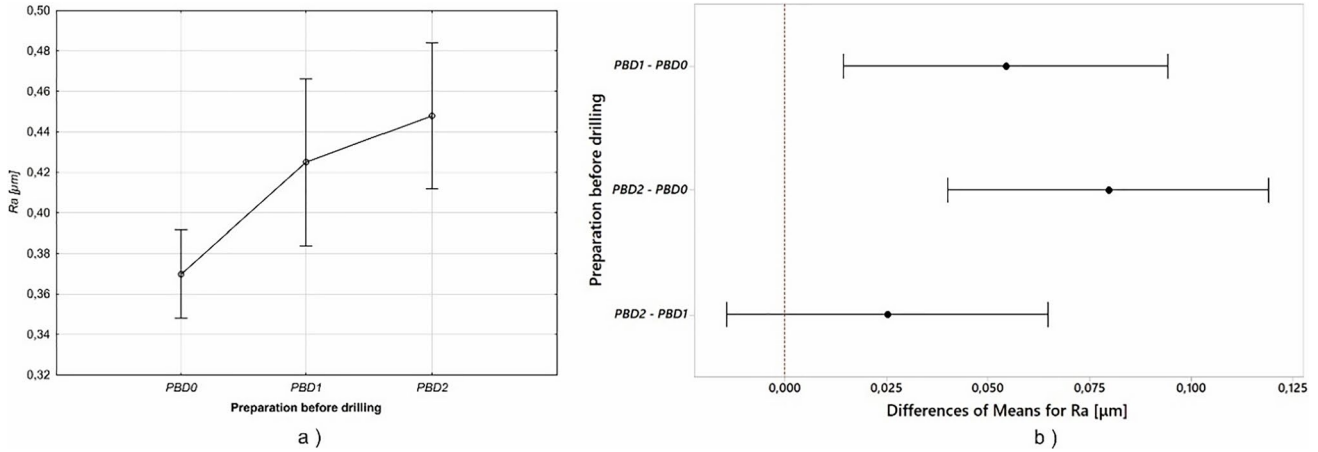

Fig. 12 Effect of pre-drilling technology on the *Ra* value of drilled holes

Table 19 Fisher individual test for differences of mean *Ra* of drilled holes for preparation before drilling

Difference of preparation before drilling levels	Difference of means	SE of difference	Individual 95% CI	<i>t-value</i>	<i>p-value</i>
<i>PBD1 - PBD0</i>	0.0543	0.0203	(0.0144; 0.0943)	2.68	0.008*
<i>PBD2 - PBD0</i>	0.0796	0.0201	(0.0401; 0.1191)	3.97	0.000*
<i>PBD2 - PBD1</i>	0.0252	0.0201	(-0.0143; 0.0648)	1.26	0.209

the drilling technology *DT1*. More significant differences in the value of the roughness parameter *Ra* when using the *PBD1* pre-drilling technology are observed when using the *DT0* drilling technology with an average value of the investigated parameter $Ra = 0.605 \mu\text{m}$ and when using the *DT2* drilling technology with an average value $Ra = 0.420 \mu\text{m}$. The minimum value of the parameter *Ra* was obtained using the drilling technology *DT3* with an average value of $0.329 \mu\text{m}$. However, the difference between the *DT3* and *DT1* drilling technologies is $-0.0015 \mu\text{m}$, and this difference is not statistically significant based on the individual Fisher test. Therefore, these achieved *Ra* values can be considered identical. When using the hole pre-preparation technology prior to drilling *PBD2*, the maximum value of the investigated parameter *Ra* is achieved when using the drilling technology

DT0 with an average value of $0.628 \mu\text{m}$. Consequently, the value of the roughness parameter *Ra* is in the interval of 0.364 to $0.402 \mu\text{m}$ when using the drilling technology *DT1*, *DT2* and *DT3*. However, the minimum value is observed for the *DT3* drilling technology.

Based on the above analyses of the change in the values of the roughness *Ra* of the drilled hole depending on the selected hole pre-preparation technology before drilling and the selected drilling technology, it is possible to build a regression model in terms of relation (1) with an extension to the influence of the individual hole preparation and drilling technologies. Table 21 shows that a statistically significant change in the *Ra* value of the drilled hole at the selected significance level $\alpha = 5\%$ is caused by the surface preparation technologies *PBD0* and *PBD1*, the drilling technology

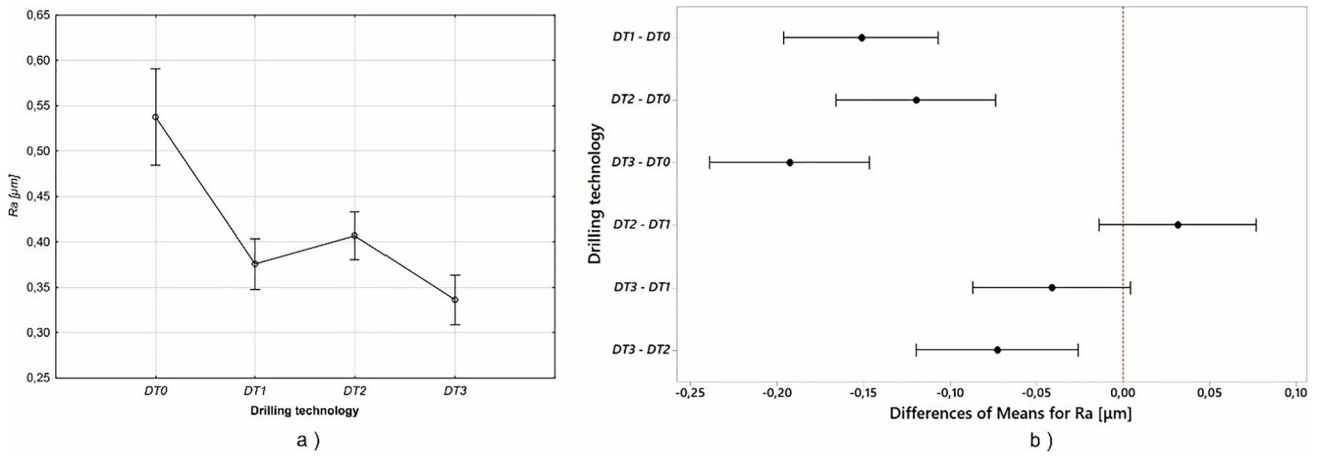

Fig. 13 Effect of the drilling technology on the Ra value of the drilled holes

Table 20 Fisher’s individual test for differences of mean Ra of the drilled holes for drilling technology

Difference of Drilling technology Levels	The Difference of Means	SE of The Difference	Individual 95% CI	t -value	p -value
DT1 - DT0	-0.1513	0.0227	(-0.1961; -0.1066)	-6.66	0.000*
DT2 - DT0	-0.1198	0.0234	(-0.1660; -0.0737)	-5.11	0.000*
DT3 - DT0	-0.1926	0.0234	(-0.2388; -0.1465)	-8.22	0.000*
DT2 - DT1	0.0315	0.0231	(-0.0139; 0.0769)	1.37	0.173
DT3 - DT1	-0.0413	0.0231	(-0.0867; 0.0041)	-1.79	0.075
DT3 - DT2	-0.0728	0.0238	(-0.1196; -0.0260)	-3.06	0.002*

Fig. 14 Chart showing the interaction of hole pre-preparation technology and drilling technology for the parameter Ra

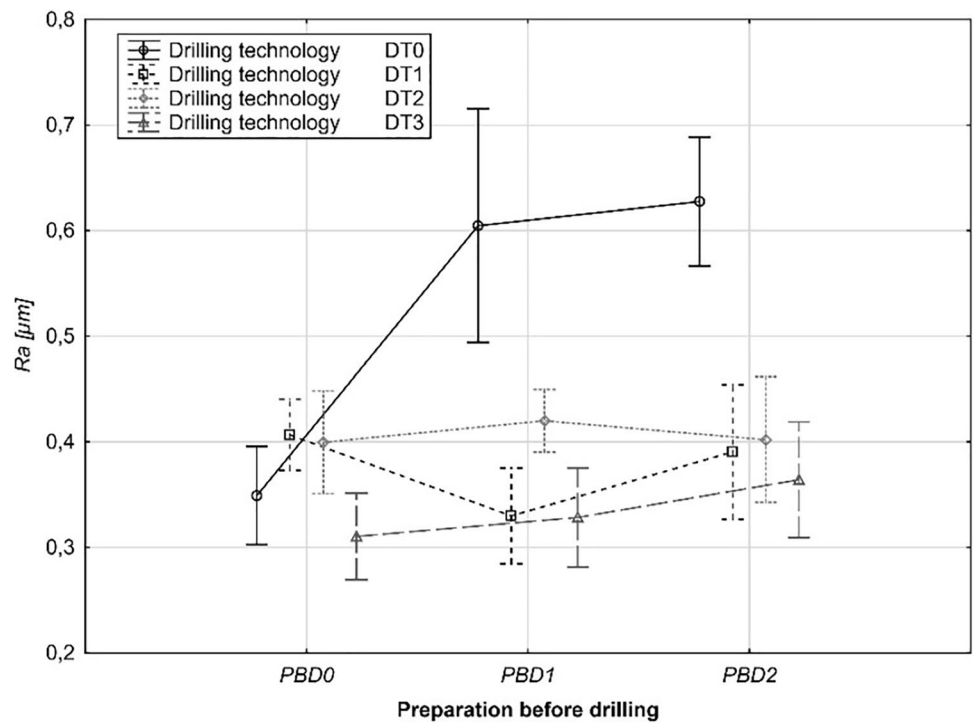

Table 21 Regression coefficients of the model for *Ra* of the drilled holes

Term	Coef	SE coef	95% CI	<i>t</i> -value	<i>p</i> -value
Constant	0.41108	0.00822	(0.39489; 0.42727)	50	0.000*
Preparation before drilling					
<i>PBD0</i>	-0.0446	0.0117	(-0.0676; -0.0217)	-3.82	0.000*
<i>PBD1</i>	0.0097	0.0117	(-0.0133; 0.0327)	0.83	0.407
<i>PBD2</i>	0.0349	0.0115	(0.0122; 0.0577)	3.03	0.003*
Drilling technology					
<i>DT0</i>	0.116	0.0142	(0.0881; 0.1438)	8.18	0.000*
<i>DT1</i>	-0.0354	0.0139	(-0.0627; -0.0081)	-2.55	0.011*
<i>DT2</i>	-0.0039	0.0145	(-0.0324; 0.0246)	-0.27	0.789
<i>DT3</i>	-0.0767	0.0145	(-0.1052; -0.0482)	-5.3	0.000*
Preparation before drilling – drilling technology					
<i>PBD0-DT0</i>	-0.1334	0.0205	(-0.1737; -0.0931)	-6.52	0.000*
<i>PBD0-DT1</i>	0.0756	0.0196	(0.0369; 0.1143)	3.85	0.000*
<i>PBD0-DT2</i>	0.037	0.0201	(-0.0025; 0.0765)	1.85	0.066
<i>PBD0-DT3</i>	0.0207	0.0207	(-0.0200; 0.0615)	1	0.316
<i>PBD1-DT0</i>	0.0679	0.0199	(0.0288; 0.1070)	3.42	0.001*
<i>PBD1-DT1</i>	-0.0554	0.0196	(-0.0941; -0.0167)	-2.82	0.005*
<i>PBD1-DT2</i>	0.0031	0.0207	(-0.0376; 0.0438)	0.15	0.880
<i>PBD1-DT3</i>	-0.0156	0.0207	(-0.0563; 0.0251)	-0.75	0.452
<i>PBD2-DT0</i>	0.0655	0.0198	(0.0266; 0.1045)	3.31	0.001*
<i>PBD2-DT1</i>	-0.0202	0.0196	(-0.0587; 0.0183)	-1.03	0.302
<i>PBD2-DT2</i>	-0.0401	0.0206	(-0.0807; 0.0004)	-1.95	0.052
<i>PBD2-DT3</i>	-0.0052	0.0200	(-0.0445; 0.0342)	-0.26	0.796

DT0, the drilling technology *DT1*, and the drilling technology *DT3*. From this table, it can be seen that the significant term in the regression equation is the absolute term Constant, which indicates that other influences are also largely responsible for the change in the value of the cylindricity, but we did not investigate them in the study.

Considering the relation (1) and the results shown in Table 21, we can write the prediction equation of the dependence of the cylindricity of the drilled hole (11).

$$\begin{aligned}
 Ra = & 0.41108 - 0.0446 \cdot PBD0 + 0.0097 \cdot PBD1 + 0.0349 \cdot PBD2 + 0.116 \cdot DT0 - \\
 & - 0.0354 \cdot DT1 - 0.0039 \cdot DT2 - 0.0767 \cdot DT3 - 0.1334 \cdot PBD0 \cdot DT0 + \\
 & + 0.0756 \cdot PBD0 \cdot DT1 + 0.037 \cdot PBD0 \cdot DT2 + 0.0207 \cdot PBD0 \cdot DT3 + \\
 & + 0.0679 \cdot PBD1 \cdot DT0 - 0.0554 \cdot PBD1 \cdot DT1 + 0.0031 \cdot PBD1 \cdot DT2 - \\
 & - 0.0156 \cdot PBD1 \cdot DT3 + 0.0655 \cdot PBD2 \cdot DT0 - 0.0202 \cdot PBD2 \cdot DT1 - \\
 & - 0.0401 \cdot PBD2 \cdot DT2 - 0.0052 \cdot PBD2 \cdot DT3
 \end{aligned}
 \quad (11)$$

After reaming the hole, it can be concluded that there is no direct influence of the pre-preparation and drilling technology on the resulting roughness of the reamed hole. Thus, the reamer refined the previous hole pre-preparation and drilling technologies without their significant influence. On the other hand, a relatively significant smaller variation

range of roughness can be observed for the holes that were drilled. In order to qualify the experimental results more objectively, the measurement results are subjected to statistical analysis.

3.3 Cluster analysis of the measured data

ANOVA analysis of variance was the basis for cluster analysis of the measured data. Cluster analysis is a summary name for a whole group of computational procedures whose aim is to decompose a given set into several relatively homogeneous subsets (clusters) so that the units (objects) inside the clusters are as similar as possible and the units (objects) belonging to different clusters are as similar as possible. In doing so, each unit is described by groups of features (variables). The result of the analysis depends on the choice of variables, the selected distance measure between objects and clusters, and the selected calculation algorithm.

In general, the cluster analysis methodology can be expressed as follows: we have n units (objects), and each unit is characterised by p features. The results of the observation (experiment) form the matrix (12),

$$\mathbf{X} = \{ \mathbf{x}_1, \mathbf{x}_2, \dots, \mathbf{x}_n \} \quad (12)$$

where the objects $\mathbf{x}_1 \cdot \mathbf{x}_2 \cdot \dots \cdot \mathbf{x}_n$ p – articulated observation vectors. Thus, the task of cluster analysis is to partition the set \mathbf{X} into the set \mathbf{S} ; $\mathbf{S} = \{ \mathbf{S}_1 \cdot \mathbf{S}_2 \cdot \dots \cdot \mathbf{S}_m \}$, where $\mathbf{S}_1 \cdot \mathbf{S}_2 \cdot \dots \cdot \mathbf{S}_m$ is m of clusters into which the grouping of objects \mathbf{x}_n is realised. In general, the number of clusters can be n , but only the number of clusters significantly smaller than the number of original units is of practical interest. It is generally required that the clusters be mutually disjunctive. The clusters formed should be as compact as possible and realistically isolated from each other, which needs to be quantified appropriately [43–45].

The task of cluster analysis (based on the values of observed variables) is to divide a set of objects into relatively homogeneous groups, where the objects in a group are similar in terms of these variables and differ from objects in other groups. Euclidean distance measures, namely Hamming, Chebyshev, or Mahalanobis, are most commonly used to assess the similarity of objects. Distance pairs of units can be arranged in a square symmetric matrix with zeros on the main diagonal. In actual clustering, different criteria may apply to determine the distance of two clusters, i.e., minimum, maximum, or average distance.

The analysis used the Euclidean distance of objects X_i and X_j to determine the dissimilarity measure of two objects (13).

$$d_3(S_h, S_k) = \frac{1}{n_h n_k} \sum_{X_i \in S_h} \sum_{X_j \in S_k} d(X_i, X_j) \quad (13)$$

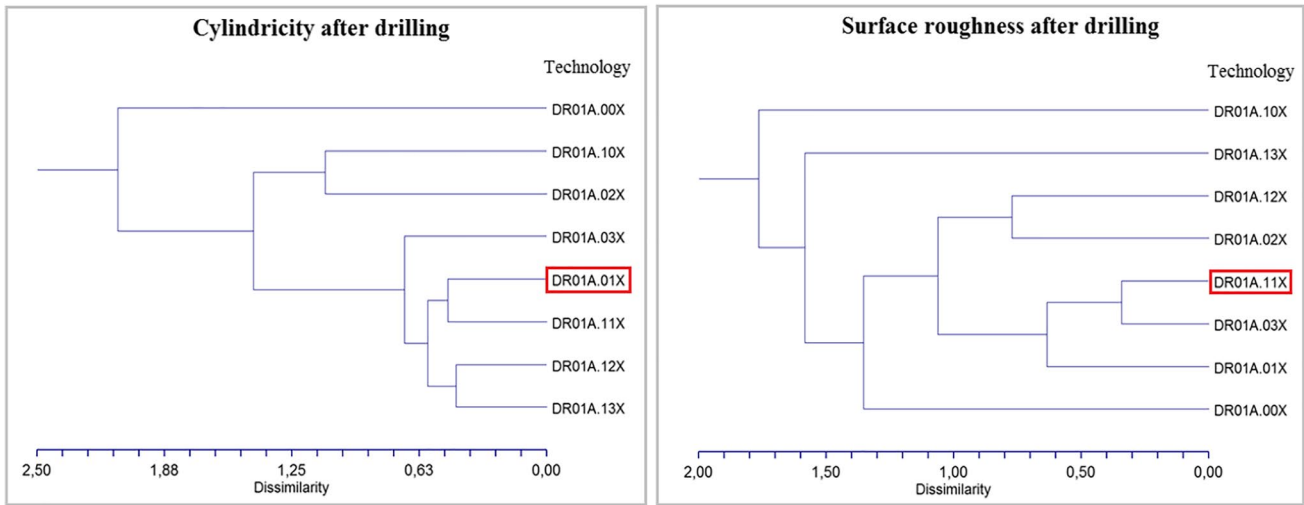

Fig. 15 Cluster analysis—comparison of different pre-preparation and hole drilling technologies, based on similarity in terms of cylindricity (left) and roughness (right)

where x_{ik} is the value of the k -th variable at the i -th object and x_{jk} is the value of the k -th variable at the j -th object.

For the actual clustering, the centroid method was selected. In the initial phase of clustering, each object forms its own cluster. In the following steps, two clusters whose distance is minimum are always merged. All clustering procedures end at $(n - 1)$ steps by merging all objects into a single cluster. Let $d_i(S_h, S_k)$ denote the distance measured between clusters S_h and S_k . Then (14) applies to the centroid clustering method.

$$d_3(S_h, S_k) = \frac{1}{n_h n_k} \sum_{X_i \in S_h} \sum_{X_j \in S_k} d(X_i, X_j) \tag{14}$$

The centroid method defines the distance measured between clusters as the distance of their diameters, i.e., (15), with (16), (17) representing the number of objects in the cluster.

$$d_4(S_h, S_k) = d(\bar{x}_h, \bar{x}_k) \tag{15}$$

$$\bar{x}_h = \frac{1}{n_h} \sum_{X_i \in S_h} X_i \tag{16}$$

$$\bar{x}_k = \frac{1}{n_k} \sum_{X_j \in S_k} X_j \tag{17}$$

The results of the measurements are presented in the form of dendrograms from which the similarity or dissimilarity of the compared elements can be read. In the presented publication, the similarity of technologies (strategies) is based on selected measurement parameters. With

respect to the conclusions drawn in the previous chapters (Fig. 15), the results of the cylindricity (Fig. 15 left) and the roughness Ra (Fig. 15 right) after drilling are compared based on similarity. The horizontal axis expresses the degree of dissimilarity. On the vertical axis, the code designation of each technology can be found (Table 2).

As a consequence of the so-called “icicle” diagram, i.e., with respect to the degree of pairwise dissimilarity, it is possible to identify the nearest neighbouring technology whose results are similar and the most distant neighbour. From the perspective of hole cylindricity, it follows that the most appropriate drilling technology is non-continuous drilling, either full-length or with a pre-drilled central hole. These results are most similar. Conversely, the most significant difference is achieved between this technology and the working feed drilling technology, again either full-length or with a drilled centre hole.

Thus, the conclusion of the analysis is clear, i.e., the drilling technology has a greater influence on the final quality of the drilled hole, followed by the hole pre-preparation technology under the declared experimental conditions.

4 Conclusion

The new findings from the research concerned the quality of the hole after drilling and the quality of the hole after reaming.

When examining the quality of the drilled hole, the following phenomena were observed and demonstrated:

- positive effect of the centre hole (pre-preparation) during drilling with the continuous working feed on the cylin-

dricity of the drilled hole (improvement of the IT accuracy class by up to 1 degree) and higher reliability of the result;

- any interruption of the cut or reduced run-in conditions has a positive impact on reducing the variation margin and increasing the accuracy of the drilled hole after drilling;
- the best option in terms of hole quality after drilling is the “non-continuous working feed” technology without affecting the hole pre-preparation;
- the highest roughness of the drilled hole in the case of the continuous working feed (the highest median value and variation range) and, on the contrary, the lowest roughness of the drilled hole in the case of the non-continuous working speed (the lowest median value and variation range) without the influence of the hole pre-preparation technology.

When investigating the quality of the reamed hole, the following phenomena were observed and demonstrated:

- slightly positive effect of the centre hole when drilling with the continuous working feed on the cylindricity of the reamed hole (improvement of the IT accuracy class by up to 1 degree) and higher reliability of the result;
- hole reaming for all variations (technologies) of pre-preparation and hole drilling leads to a clear refinement of the holes, both in median value and in reduction of the variation margin;
- some (less pronounced) influence of the centre hole drilling on achieving higher accuracy of cylindricity (accuracy class IT6);
- the reamer has a high ability to refine holes (accuracy class up to IT 6) for lower quality holes (accuracy class from IT 10) after drilling, i.e. the reamer represents high stability and reliability;
- only an indirect effect of the pre-preparation and drilling technology on the resulting roughness of the reamed hole; in contrast, a significantly smaller variation range of roughness for holes that have been drilled.

Because the reamer exhibited a high level of refinement regardless of the previous drilling or hole pre-preparation, further partial research activities will be focused on reducing the stiffness of the reamer in order to modify its design.

Acknowledgements The present contribution has been prepared under project LO1502 “Development of the Regional Technological Institute” under the auspices of the National Sustainability Programme I of the Ministry of Education of the Czech Republic aimed to support research, experimental development, and innovation.

Author contribution Conceptualization: Jaroslava Fulemová; methodology: Jan Řehoř; validation: Jan Valíček, Milena Kušnerová and Marta Harničárová.; formal analysis: Marta Harničárová and Jan Valíček;

investigation: Miroslav Gombár and Jan Kutlwašer; data curation: Tomáš Zatloukal and Alena Vagaská; project administration: Jan Řehoř. All authors read and approved the final manuscript.

Funding Open access publishing supported by the National Technical Library in Prague.

Declarations

Conflict of interest The authors declare no competing interests.

Open Access This article is licensed under a Creative Commons Attribution 4.0 International License, which permits use, sharing, adaptation, distribution and reproduction in any medium or format, as long as you give appropriate credit to the original author(s) and the source, provide a link to the Creative Commons licence, and indicate if changes were made. The images or other third party material in this article are included in the article's Creative Commons licence, unless indicated otherwise in a credit line to the material. If material is not included in the article's Creative Commons licence and your intended use is not permitted by statutory regulation or exceeds the permitted use, you will need to obtain permission directly from the copyright holder. To view a copy of this licence, visit <http://creativecommons.org/licenses/by/4.0/>.

References

1. Motorcu AR, Kuş A, Durgun I (2014) The evaluation of the effects of control factors on surface roughness in the drilling of Waspaloy superalloy. *Measurement* 58:394–408
2. Sharman ARC, Amarasinghe A, Ridgway K (2008) Tool life and surface integrity aspects when drilling and hole making in Inconel 718. *J Mater Process Technol* 200:424–432
3. Popa A, Dutilh V, Baili M., Dessein G, Perrin G (2010) Identification of influent factors on surface integrity in nickel-base superalloy drilling. In 19th International Conference on Manufacturing Systems; 11–12 Nov 2010. Bucharest. Romania
4. Aamir M, Tolouei-Rad M, Giasin K, Nosrati A (2019) Recent advances in drilling of carbon fiber–reinforced polymers for aerospace applications: A review. *Int J Adv Manuf Technol* 105:2289–2308
5. Pirtini M, Lazoglu I (2005) Forces and hole quality in drilling. *Int J Mach Tools Manuf* 45:1271–1281
6. Yang JA, Jaganathan V, Du R (2002) A new dynamic model for drilling and reaming processes. *Int J Mach Tools Manuf* 42:299–311
7. dos Reis A, da Silva RB, Silva LG, Machado ÁR, Arencibia RV, Ruzzi RDS, Jackson MJ, Zeilmann RP (2020) Analyses of two manufacturing systems in drilling of CGI: drilling and reaming × drilling. *Int J Adv Manuf Technol* 7:2861–2874
8. Binali R, Kuntoğlu M, Pimenov DY, Usca ŪA, Gupta MK, Korkmaz ME (2022) Advance monitoring of hole machining operations via intelligent measurement systems: A critical review and future trends. *Measurement* 201:111757
9. Dilley DN, Bayly PV, Schaut AJ (2005) Effects of the chisel edge on the chatter frequency in drilling. *J Sound Vib* 281:423–438
10. Roukema JC, Altintas Y (2007) Generalized modeling of drilling vibrations. Part I: Time domain model of drilling kinematics, dynamics and hole formation. *Int. J Mach Tools Manuf* 47:1455–1473
11. Roukema JC, Altintas Y (2007) Generalized modeling of drilling vibrations. Part II: Chatter stability in frequency domain. *Int J Mach Tools Manuf* 47:1474–1485
12. Dilley DN, Bayly PV, Whitehead BT, Calvert SG (2005) An analytical study of the effect of process damping on reamer vibrations. *J Sound Vib* 280:997–1015

13. Zhelezov GS, Andreeva SG (2013) Final surface roughness in reaming holes. *Russ Eng Res* 33:522–524
14. Zhelezov GS, Andreeva SG (2016) Influence of cutting-edge errors on reamed-surface quality. *Russ Eng Res* 36:53–55
15. Bhattacharyya O, Jun MB, Kapoor SG, DeVor RE (2006) The effects of process faults and misalignments on the cutting force system and hole quality in reaming. *Int J Mach Tools Manuf* 46:1281–1290
16. De Chiffre L, Belluco W (2002) Investigations of cutting fluid performance using different machining operations. *Tribol Lubr Technol* 58:22–29
17. Pilný L, Müller P, De Chiffre L (2014) Reproducibility of a reaming test. *Int J Manuf Res* 9:157–172
18. Hauer T, Haydn M, Abele E (2012) Influence of a diagonal pre-drilled hole on hole quality during the reaming process using multiblade tools. *J Braz Soc Mech Sci Eng* 34:569–573
19. Eifer T, Wiebel M, Haydn M, Hauer T, Birkhofer H, Bohn A (2012) Non-probabilistic uncertainty analysis in early design stages. In: DS 70: Proceedings of DESIGN 2012, the 12th International Design Conference, Dubrovnik, Croatia
20. Haydn M, Hauer T, Abele E (2012) Methods for the control of uncertainty in multilevel process chains using the example of drilling/reaming. *Appl Mech Mater* 104:103–113
21. Melo TFL, Ribeiro Filho SLM, Arruda ÊM, Brandão LC (2019) Analysis of the surface roughness, cutting efforts, and form errors in bore reaming of hardened steel using a statistical approach. *Measurement* 134:845–854
22. Dedeakayoğulları H, Kaçal A, Keser K (2022) Modeling and prediction of surface roughness at the drilling of SLM-Ti6Al4V parts manufactured with pre-hole with optimized ANN and ANFIS. *Measurement* 203:112029
23. Schorr S, Möller M, Heib J, Fang S, Bähre D (2020) Quality prediction of reamed bores based on process data and machine learning algorithm: A contribution to a more sustainable manufacturing. *Procedia Manuf* 43:519–526
24. Varatharajulu M, Duraiselvam M, Kumar MB, Jayaprakash G, Baskar N (2021) Multi criteria decision making through TOPSIS and COPRAS on drilling parameters of magnesium AZ91. *J Magnes Alloys* 10:2857–2874
25. Kouril K, Cep R, Janasek A, Kriz A, Stancekova D (2014) Surface integrity at reaming operation by MT3 head. *Manuf Technol* 14:193–199
26. Fiala S, Kouřil K, Řehoř J (2012) Research and development of high precise cutting tools of new generation with the use of innovation technologies and progressive materials. In: The interim report to the project TA02010236 for 2012. HAM-FINAL s.r.o, Brno
27. Řehoř J, Fulemová J, Rut D, Třísková V, Kutlwašer J, Kouřil K (2015) Reaming of very precise holes in hydrostatic component. *Manuf Technol* 15:409–415
28. Pokorná V, Roub J, Řehoř J, Fulemová J (2016) Research Study on Influence of Predefined Factors on Drilling Produced Hole before Reaming. *Technol Eng* 3:15–18
29. Giridharan P, John S (2020) Combined Drilling and Reaming Operation in Robot and CNC. *IOP Conf Ser: Mater Sci Eng* 912:032086
30. Cardoso LG, Madeira DS, Ricomini TE, Miranda RA, Brito TG, Paiva EJ (2021) Optimization of machining parameters using response surface methodology with desirability function in turning duplex stainless steel UNS S32760. *Int J Adv Manuf Technol* 117:633–1644
31. Susac F, Stan F (2020) Experimental investigation, modeling and optimization of circularity, cylindricity and surface roughness in drilling of PMMA using ANN and ANOVA. *Mater Plast* 57:57–68
32. Sivam SSS, Kumaran D, Harshavardhana N (2022) Multi-objective optimisation of drilling process parameters in AISi6Cu3 via Grey Relational analysis and ANOVA. *Int J Manuf. Res* 17:268–282
33. Rubi CS, Prakash JU, Čep R, Elangovan M (2022) Optimization of process variables in the drilling of LM6/B4C composites through grey relational analysis. *Materials* 15:4860
34. Zolpakar NA, Yasak MF, Pathak S (2021) A review: use of evolutionary algorithm for optimisation of machining parameters. *Int J Adv Manuf Technol* 115:31–47
35. Edwards AWF (2005) R.A. Fisher, Statistical methods for research workers, first edition (1925). In: Grattan-Guinness I (ed) Landmark writings in western mathematics, 1640–1940. Elsevier, Amsterdam, pp 856–870
36. Yıldız AR (2019) A novel hybrid whale–Nelder–Mead algorithm for optimization of design and manufacturing problems. *Int J Adv Manuf Technol* 105:5091–5104
37. Yıldız AR (2013) Cuckoo search algorithm for the selection of optimal machining parameters in milling operations. *Int J Adv Manuf Technol* 64:55–61
38. Yıldız BS, Pholdee N, Bureerat S, Erdaş MU, Yıldız AR, Sait SM (2021) Comparison of the political optimization algorithm, the Archimedes optimization algorithm and the Levy flight algorithm for design optimization in industry. *Mater Test* 63:356–359
39. Yıldız BS, Patel V, Pholdee N, Sait SM, Bureerat S, Yıldız AR (2021) Conceptual comparison of the ecogeography-based algorithm, equilibrium algorithm, marine predators algorithm and slime mold algorithm for optimal product design. *Mater Test* 63:336–340
40. Rigdon SE, Pan R, Montgomery DC, Freeman L (2022) Design of Experiments for Reliability Achievement, vol 1. John Wiley & Sons
41. Collett D (2003) Modeling binary data. Chapman & Hall CRC, London
42. Agresti A (2003) Categorical data analysis. John Wiley & Sons, New York
43. Hosmer DW Jr, Lemeshow S, Sturdivant RX (2013) Applied logistic regression John Wiley & Sons, New York
44. Fleiss JL, Levin B, Paik MC (2013) Statistical methods for rates and proportions. John Wiley & Sons, New York
45. Schiefer H, Schiefer F (2021) Statistics for Engineers. Springer Fachmedien Wiesbaden

Publisher's note Springer Nature remains neutral with regard to jurisdictional claims in published maps and institutional affiliations.